

INSTALLATION INSTRUCTIONS

Mallory Fuel Series 110 and 140 Electric Fuel Pump PN 29259, PN 29256, PN 29209

NOTE: DO NOT RUN THIS PUMP WITHOUT FUEL (EXCEPT FOR BRIEF PERIODS WHILE PRIMING).

Parts Included in this kit:

1 - Electric Fuel Pump	4 - Nut, 5/16" Flat
1 - Bag, Fuel Pump Hardware	1 - Fuse, 7.5 AMP
1 - Fuse Holder	
4 - Bolt, Steel 5/16"	A fuel pressure regulator is included with COMP
1 - Ring Terminal	PUMP® 140 Series Electric Fuel Pump Kit
4 - Washer, Steel 5/16" Flat	Part Nos. 4140, 4140M, 4141, 4141A, 4142 and 4142A.

Read all instructions carefully before beginning installation.

GENERAL INFORMATION

The Mallory Fuel 110 Series Electric Fuel Pump is a high volume fuel pump designed for high performance street and marine applications. The operating fuel pressure is factory set at 7 PSI. Normally, a fuel pressure regulator is not necessary. We recommend a 5/16" or larger fuel line with this fuel system.

The Mallory Fuel 140 Electric Fuel Pump is a high volume high pressure fuel pump designed for high performance street, racing and marine applications. The operating fuel pressure is factory set at 12 PSI. This pump must be used with a fuel pressure regulator to prevent carburetor flooding. We recommend a 3/8" or larger fuel line with this fuel system.

The Mallory Fuel Series 140 Part Nos. 4142 and 4142A come with a 3 Port Return Style Regulator. These fuel systems must have a fuel return line installed between the fuel pressure regulator's fuel return port and the fuel tank. We recommend a 3/8" or larger fuel return line.

When installing the fuel pump fittings, use a thread sealant compound (you can find this at a hardware store) on the fitting threads. Do not use Teflon tape. Teflon tape can get into the Gerotor and lock the pump. Also, do not overtighten the fittings. This could damage the fuel chamber.

Be sure to install a suitable fuel filter (minimum 40 micron filtration) between the fuel tank and the fuel pump. The Mallory COMP FILTER® Series Part No. 3140 is recommended. This prevents debris from becoming wedged in the fuel pump's Gerotor and locking it.

SPECIFICATIONS

Operating pressure:	Mallory Fuel 110 Series factory set at
Inlet/outlet thread sizes:	3/8" NPT
Oil pressure switch rating:	7.5 AMP
Over current protection:	7.5 AMP fuse
Gasoline fuel applications:	Part Nos. 4110, 4110M, 4140, 4140M, 4141, 4142 and 4150
Alcohol/Methanol fuel applications:	Part Nos. 4110A, 4141A, 4142A and 4150A

The Mallory Fuel 110 Series Part No. 4110M and the Mallory Fuel 140 Series Part No. 4140M have been tested to UL 1130 AND SAE J1171 specifications and meet U.S. Coast Guard, American Boat and Yacht Council, Inc. and the Nation Fire Protection Association for Motor Craft NFPA No. 302 requirements for marine usage.

SERVICE PARTS:

- Part No. 3146 A Brush Kit
- Part No. 3165 Seal/Repair Kit, Gasoline (may be used to convert alcohol/methanol fuel pumps to gasoline)
- Part No. 3166 Seal/Repair Kit, Alcohol/Methanol (may be used to convert gasoline fuel pumps to alcohol/methanol)

This product is covered under one or more of the following U.S.

Patents:5,007,806; 4,998,557; 5,111,793; 5,123,436; 5,186,147

MOUNTING PROCEDURE

Step 1

Mount the pump as close as possible to the fuel tank (at or below the level of the fuel tank pickup) in a well ventilated area with minimal exposure to road debris. Avoid exposing the pump and fuel lines to moving parts and hot surfaces, such as the exhaust system. Increasing distance between the pump and tank will decrease pump efficiency.

Step 2

Using the pump mounting bracket as a template, locate mounting holes on a solid member, such as the vehicle chassis. Drill holes for 5/16" bolts. To ensure against a potential fire hazard from pump flooding, mount the pump in a vertical position with the motor on top.

Step 3

Connect fuel lines as shown in Figure 2 (A, B, C, or D). If your fuel system requires a fuel pressure regulator, proceed to the instructions with the fuel pressure regulator.

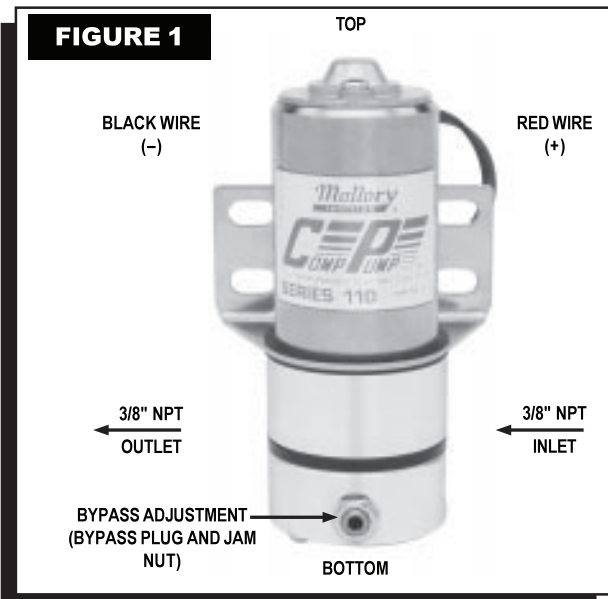

WIRING PROCEDURE

Wiring the pump to an oil pressure switch will provide power only when the ignition switch is on and the engine is running. This will prevent the pump from running if your engine stalls. Use 14 gauge wire or larger and be sure to disconnect the battery ground cable before wiring the pump. Refer to Figure 3 when connecting the pump to an oil pressure switch.

The pump may be wired directly to the ignition switch "ON" terminal and grounded to the frame or battery. Refer to Figure 4 when connecting the pump to the ignition switch "ON" terminal.

MAINTENANCE - PUMP DISASSEMBLY

If your pump fails to produce adequate pressure, it may require cleaning. Follow the steps below to disassemble and clean your Mallory Electric Fuel Pump. Refer to Figure 5 while performing the following steps.

Step 1

Remove the pump from the vehicle and clean pump exterior. Place the pump on its side on a clean work surface. Scribe or draw a line across the pump housing, port plate and fuel chamber so that you can reassemble the pump correctly.

Step 2

Remove the two fuel chamber screws from the bottom of the pump. Remove the fuel chamber and port plate. NOTE: Do not drop the Gerotor from the pump cavity.

Step 3

Separate the port plate from the fuel chamber. Inspect the flame arrestor screen in the fuel chamber and clean it if necessary.

Step 4

Place your hand beneath the Gerotor and hold the pump in an upright position. The Gerotor should slide out of the pump housing and into your hand. NOTE: Observe the position of the Gerotor and be careful not to reverse it when you reassemble the pump.

Step 5

Release the jam nut on the bypass plug. Mark the bypass plug location and count the number of turns required to remove it. Remove the bypass spring and plunger. Inspect the plunger. The plunger surface should be clean and slide freely in the chamber. Check the plunger pad and remove any debris embedded in its surface. Reinstall the bypass spring and plunger. Clean the bypass plug. Apply thread sealant compound to the bypass plug threads. Install the bypass plug. Tighten the jam nut.

Step 6

Clean the Gerotor and install it in the pump housing. Inspect the O-ring and gasket. Replace them if necessary. Place the gasket and port plate on the fuel chamber. Install

FIGURE 2A

FUEL PUMP KIT PART NO. 4110 (OPTIONAL FUEL PRESSURE REGULATOR), 4140 OR 4141 WITH FUEL PRESSURE REGULATOR PART NO. 4207 OR 4209

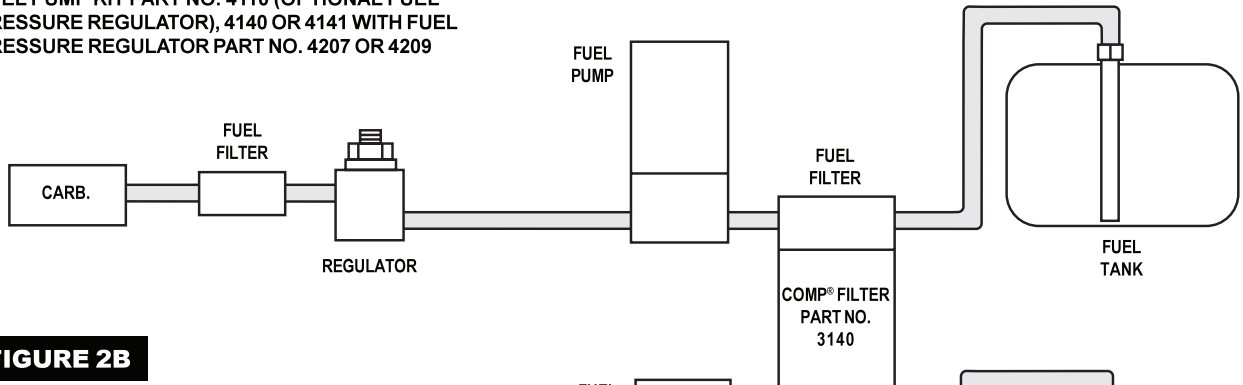

FIGURE 2B

FUEL PUMP KIT PART NO. 4142 WITH FUEL PRESSURE REGULATOR PART NO. 4309

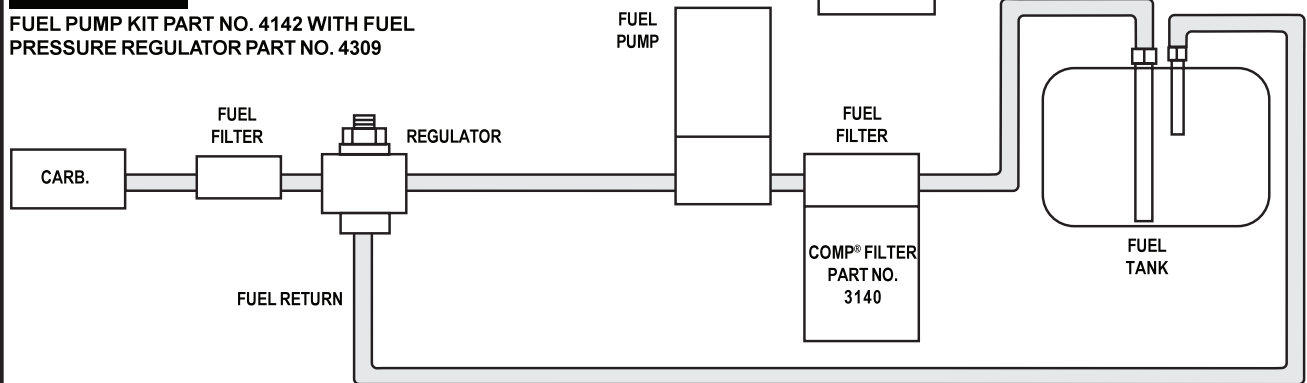

FIGURE 2C

FUEL PUMP KIT PART NO. 4140 OR 4141 WITH FUEL PRESSURE REGULATOR PART NO. 4207 OR 4209

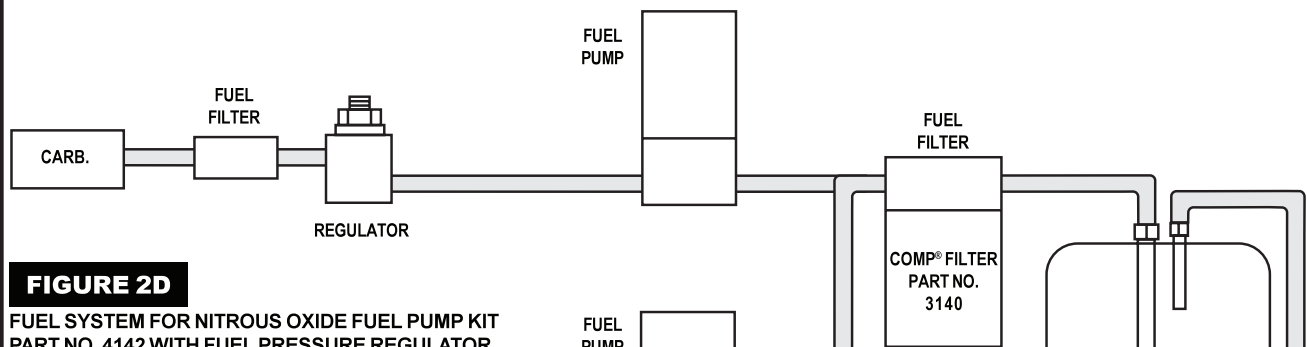

FIGURE 2D

FUEL SYSTEM FOR NITROUS OXIDE FUEL PUMP KIT PART NO. 4142 WITH FUEL PRESSURE REGULATOR PART NO 4309

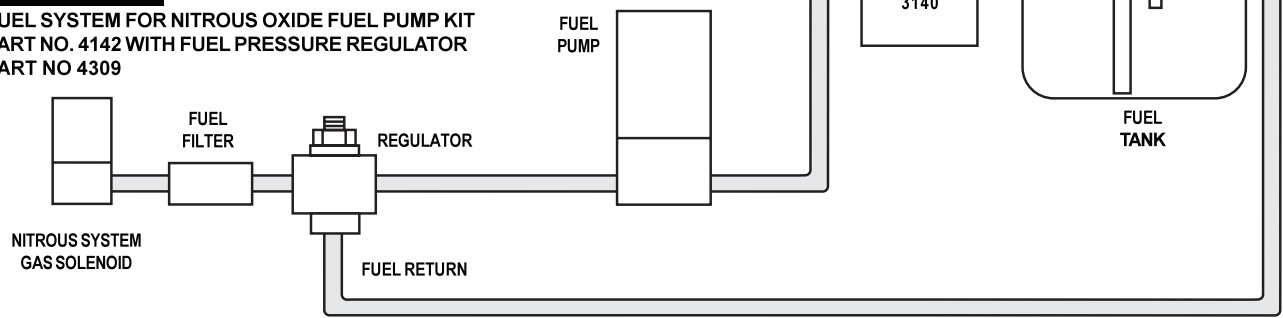

FIGURE 3

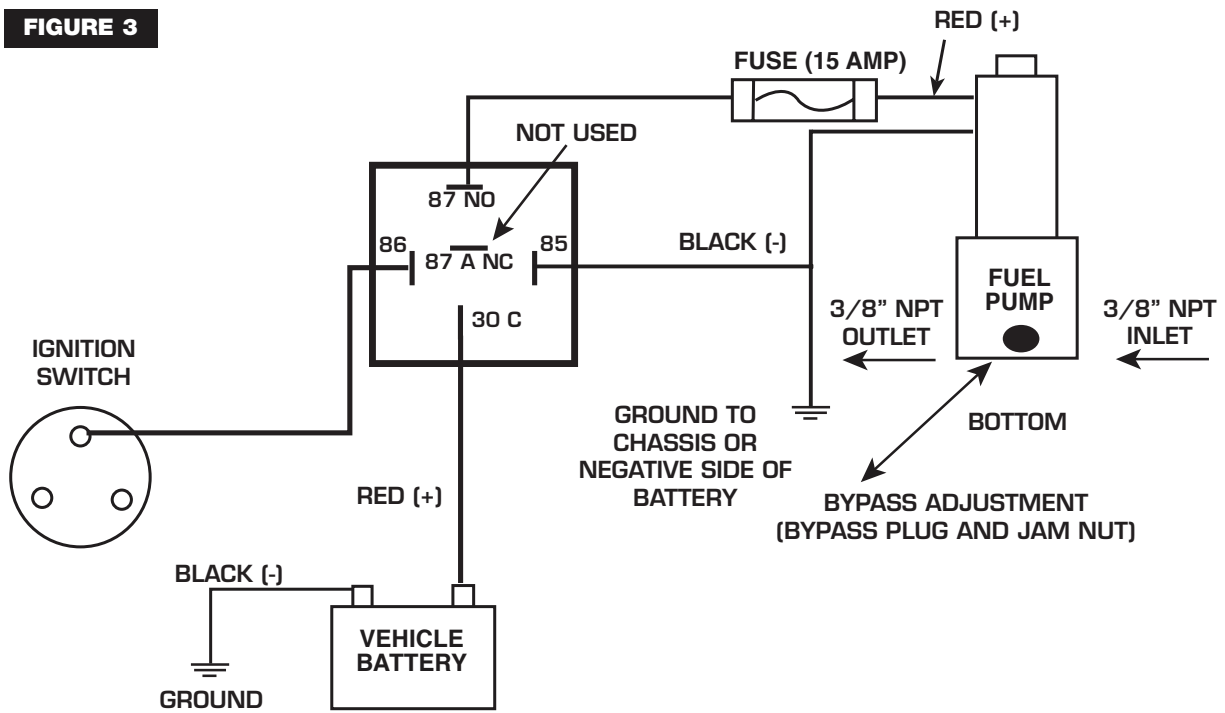
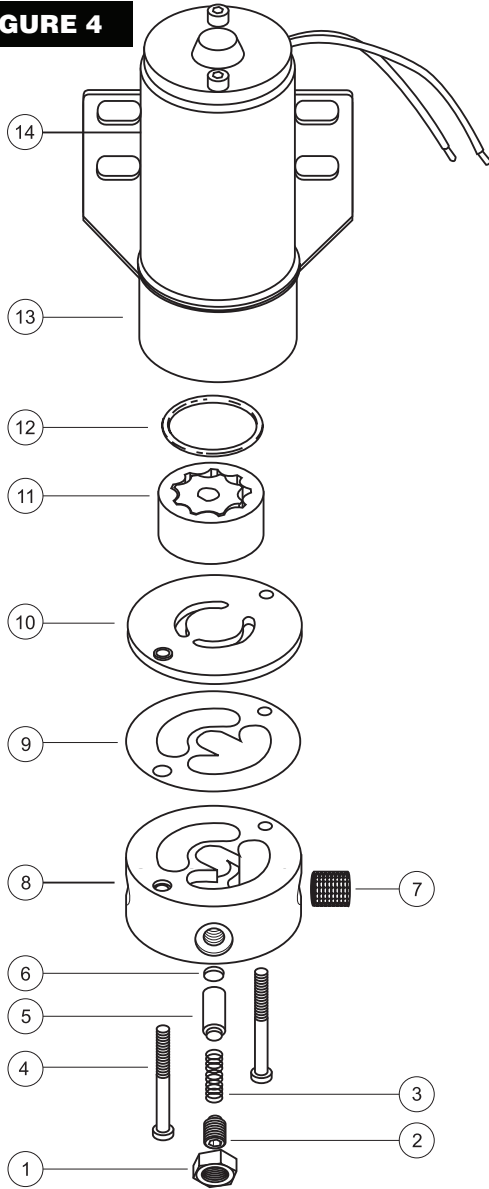
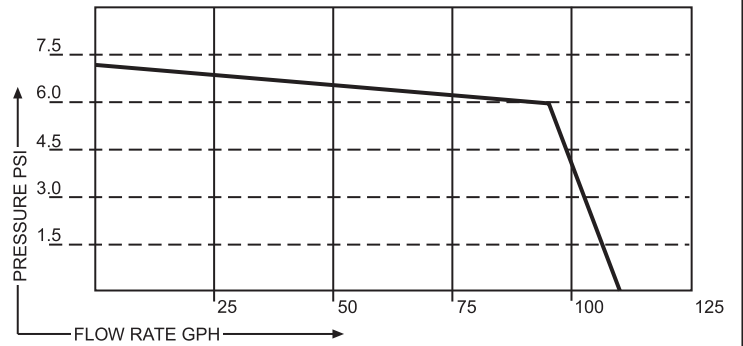

FIGURE 4



- 1 JAM NUT
- 2 BYPASS PLUG
- 3 BYPASS SPRING
- 4 SCREW, FUEL CHAMBER (2)
- 5 BYPASS PLUNGER
- 6 PAD, BYPASS PLUNGER
- 7 SCREEN, FLAME ARRESTER
- 8 FUEL CHAMBER
- 9 GASKET, FUEL CHAMBER
- 10 PORT PLATE
- 11 GEROTOR
- 12 O-RING
- 13 GEROTOR HOUSING
- 14 MOTOR

COMP PUMP® SERIES 110 FLOW VS. PRESSURE @12.5VDC
(FLOW INCREASES AS PRESSURE DECREASES)



COMP PUMP® SERIES 140 FLOW VS. PRESSURE @12.5VDC
(FLOW INCREASES AS PRESSURE DECREASES)

