



## INSTALLATION INSTRUCTIONS

# HYFIRE® 6AL2 ELECTRONIC IGNITION CONTROL PART NO 6861M

### PARTS INCLUDED:

- |   |                               |   |                           |
|---|-------------------------------|---|---------------------------|
| 1 | HYFIRE® 6AL2 Ignition Control | 5 | 1/4" Male Disconnects     |
| 4 | #10 Sheet Metal Screws        | 5 | 1/4" Female Disconnects   |
| 2 | Wire Ties                     | 1 | Rubber Grommet            |
| 2 | Ring Terminals, Insulated     | 2 | Cable Clamps              |
| 1 | 1-amp/100 volt Diode          | 1 | Magnetic Pickup Extension |
| 2 | 1/4" Tab Terminals            |   |                           |

### GENERAL INFORMATION

The HYFIRE® 6AL2 includes a two stage RPM limiter. You can set various RPM limits using the switches that are located in the end bracket. See Figure 1 of this instruction form for more information about the rev limiting features.

#### Battery

The HYFIRE® 6AL2 Ignition Control operates on any negative ground, 12 volt electrical system with a distributor. It will also work with 16 volt batteries and can withstand a momentary spike of 24 volts in case of jump starts. This system delivers full voltage with a supply of 10-18 volts, and operates with a supply voltage as low as 8 volts.

If your application does not use an alternator, allow at least 15 amp/hours for every half hour of operation. If you crank the engine with the same battery or other accessories, such as an electric fuel or water pump, increase the amp/hour rating.

#### Coils

For optimum performance with your HYFIRE® 6AL2 Ignition Control, we recommend a Mallory PROMASTER® Coil P/N 29440 or 30440 or 30441 Mallory PROMASTER® E. For continuous high RPM use, coil part numbers 29625, 30625 or 30626 can also be used. You may also use most stock coils or aftermarket coils designed as stock replacements.

**NOTE: Do not use Mallory's PROMASTER® Coil P/N 28880.**

#### Tachometers

The yellow wire on the HYFIRE® 6AL2 Ignition Control provides a trigger signal for tachometers, shift lights, or other add-on RPM activated devices. This wire produces a 12 volts square wave signal with a 20% duty cycle.

Some vehicles with factory tachometers may require a tach adapter to work with the HYFIRE® 6AL2 Ignition Control. If your GM vehicle uses an inline filter, it may cause the tach to drop to zero on acceleration. If this occurs, bypass the filter. For more information on tachometers, see page 4.

#### Spark Plugs

Using the correct spark plug and heat range is important for optimum performance. Because there are so many variables to consider, we suggest starting with your engine manufacturer's spark plug recommendation. From there, you can experiment with small changes in plug gap and heat range to obtain the best performance from your engine. Use the chart at right as a starting point. We also recommend non-resistor spark plugs.

#### Foreign Vehicles

Because of modern fuel injection systems, some foreign vehicles may require a tachometer/fuel injection adapter to work with the HYFIRE® 6AL2 Ignition Control.

**NOTE: Do not install the HYFIRE® 6AL2 Ignition Control in any vehicle that is originally equipped with a CD ignition control.**

#### Spark Plugs and Wires

High quality, spiral wound wire and proper routing are essential to the operation of the HYFIRE® 6AL2 Ignition Control. This type of wire provides a good path for the spark to follow while minimizing electromagnetic interference (EMI).

**NOTE: Do not use solid core spark plug wires with the HYFIRE® 6AL2 Ignition Control.**

#### Routing

Wires should be routed away from sharp edges, moving objects, and heat sources. Wires that are next to each other in the engine's firing order should be separated. For example, in a Chevy V8 with a firing order of 1-8-4-3-6-5-7-2, the #5 and #7 cylinders are positioned next to each other on the engine as well as in the firing order. Voltage from the #5 wire could jump to the #7 wire. This could cause detonation and engine damage.

For added protection against cross-fire, Mallory offers PRO SHIELD insulated sleeving. Pro Shield is a glass woven, silicone coated protective sleeve that slides over your plug wires. It also helps reduce damage from heat and sharp objects.

## MISCELLANEOUS INFORMATION

### Sealing

Do not attempt to seal the HYFIRE® 6AL2 Ignition Control. All of the circuits of a HYFIRE® 6AL2 receive a conformal coating of sealant that protects the electronics from moisture. Sealing the HYFIRE® 6AL2 will not allow any moisture that seeps in through the grommets to drain and may result in corrosion.

### Welding

To avoid any damage to the HYFIRE® 6AL2 Ignition Control when welding on the vehicle, disconnect the positive (red) and negative (black) power cables of the HYFIRE® 6AL2 Ignition Control. It is also a good idea to disconnect the tachometer ground wire as well.

### Distributor Cap and Rotor

We recommend installing a new distributor cap and rotor when installing the HYFIRE® 6AL2 Ignition Control. Be sure the cap is clean inside and out, especially the terminals and rotor tip. On vehicles with smaller caps, it is possible for the air inside the cap to become electrically charged causing crossfire which can result in misfire. You can prevent this by drilling a couple of vent holes in the cap. Drill the holes between terminals at rotor height, facing away from the intake. If needed, place a small piece of screen over the holes to act as a filter.

### HYFIRE® 6AL2 Diagnostic LED

On the end panel of your HYFIRE® 6AL2 ignition there is a small hole. Behind this hole is a red LED indicator. This serves two purposes: when you first turn on the ignition switch, the LED will flash rapidly 3 times. This indicates that the ignition system has power, and that the microprocessor is running properly. In addition, the LED will flash when receiving a proper trigger signal from the vehicle. If, after a normal power-up, the LED doesn't flash when cranking the engine, you should check your triggering circuit for problems. If the LED flashes when the engine is cranked, but there is still no spark, the problem lies somewhere else.

### HYFIRE® 6AL2 Cylinder Selection

Your HYFIRE® 6AL2 Ignition comes from the factory set up for 8 cylinder operation. If you want to use this ignition with a 4 or 6 cylinder engine, rotate the center rotary switch, accessible through the end plate, to the proper number of cylinders. To select the 4 cylinder mode, turn the switch to the "4" position. See Figure 1.

## RPM LIMITER SETTINGS

### Main RPM Limiter

The main RPM Limiter is adjusted by using the pair of switches on the left side of the end plate. The left switch of the pair is for 1,000's and right is for 100's. To eliminate the RPM Limiter, simply rotate the switches to a setting above the engine's maximum RPM. See Figure 1.

## Rotary Switch Position Examples

Switch #1	Switch #2	RPM Limit
1	0	1,000
2	4	2,400
2	5	2,500
6	0	6,000
7	8	7,800
9	9	9,900

### Auxiliary RPM Limiter

The Auxiliary RPM Limiter is adjusted using the pair of rotary switches on the right side of the end plate. They are adjusted the same as the Main RPM Limiter, the left switch of the pair is used to adjust the 1,000's and the right switch of the pair adjusts the 100's.

## MOUNTING

The HYFIRE® 6AL2 Ignition Control can be mounted in any position. If you mount it in the engine compartment, keep it away from moving objects and heat sources. Do not mount the unit in an enclosed area, such as the glove box. When you find a suitable location to mount the unit, make sure all wires of the ignition reach their connections. Hold the ignition in place and mark the location of the mounting holes. Use a 1/8" drill bit to drill the holes. Use the supplied self-tapping screws to mount the box.

## WIRING

### Wire Length

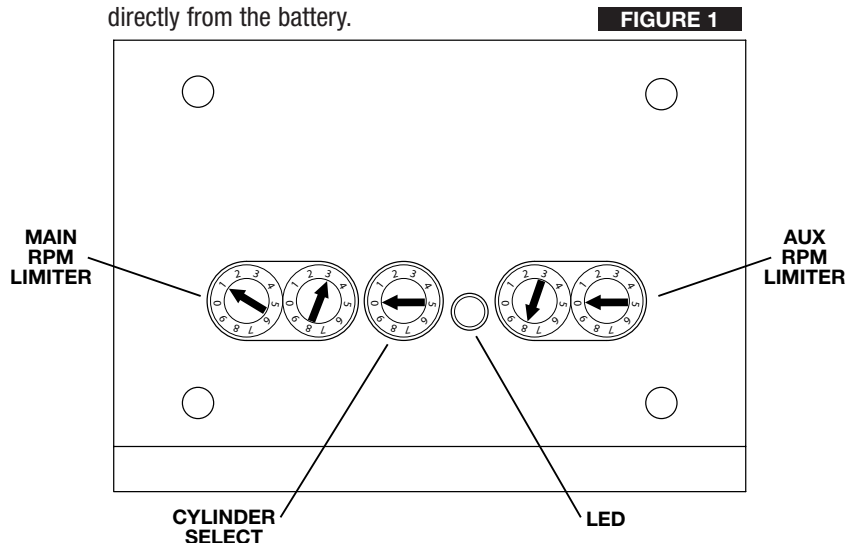
All of the wires of the HYFIRE® 6AL2 Ignition Control may be shortened as long as quality connectors are used or soldered in place. To lengthen the wires, use one size larger gauge wire (12 gauge for power leads, 16 gauge for all others). Use the proper connectors to terminate all wires. All connections must be soldered and sealed.

### Grounds

A poor ground connection can cause many frustrating problems. When a wire is specified to go to ground, connect it to the chassis. Always connect a ground strap between the engine and chassis. Connect any ground wires to a clean, paint-free metal surface.

### Ballast Resistor

If your vehicle has a ballast resistor in line with the coil wiring, it is not necessary to bypass it. This is because the HYFIRE® 6AL2 Ignition Control receives its main power directly from the battery.



## WIRE FUNCTIONS

### Power Leads (enclosed in 6" of black shrink tubing)

The two heavy gauge wires (14 gauge) that deliver battery voltage to the ignition:

**Heavy Red** Connects directly to the battery positive (+) terminal or to a positive battery junction. It could also be connected to the positive side of the starter solenoid. **NOTE: Never connect this wire to the alternator.**

**Heavy Black** Connects to frame or chassis ground.

### Trigger and Coil Leads

**Small Red** Connects to a switched 12 volt source, such as the ignition key.

**Orange** Connects to the positive (+) terminal of the coil. **NOTE: This is the only wire that makes electrical contact with the coil positive (+) terminal.**

**Small Black** Connects to the negative (-) terminal of the coil. **NOTE: This is the only wire that makes electrical contact with the coil negative (-) terminal.**

### Trigger Wires

Either of two circuits will trigger the HYFIRE® 6AL2 Ignition Control: a points circuit (white wire) or a magnetic pickup circuit (violet and green wires). **NOTE: The two circuits will never be used together.**

**White** Connects to points, electronic ignition amplifier output or to the green wire of a Mallory timing accessory. When this wire is used, the magnetic pickup connector is not used.

**Violet/Green** These wires are routed together in one harness to form the magnetic pickup connector. The connector plugs directly into a Mallory distributor or crank trigger. It will also connect to factory magnetic pickups or other aftermarket pickups. The violet wire is positive (+) and the green is negative (-). When these wires are used, the white wire is not used. Consult the chart that shows the polarity of other common magnetic pickups.

**Yellow** Connects to the tachometer.

**Blue** This wire is used to activate the Auxiliary (Staging) RPM Limiter. It is activated by applying 12 volts to the wire.

## ROUTING WIRES

Route all wires away from heat sources, sharp edges, and moving objects. Route the trigger wires separate from the other wires and spark plug wires. If possible, route them along a ground plane, such as the block or firewall, which creates an electrical shield. The magnetic pickup wires should be routed separately and twisted together to help reduce extraneous interference.

**WARNING: The HYFIRE® 6AL2 Ignition Control is a capacitive discharge ignition. High voltage is present at the coil primary terminals. Do not touch these terminals or connect test equipment to them.**

COMMON COLORS FOR MAG PICKUP WIRES		
Distributor	Mag +	Mag -
Mallory Crank Trigger	Purple	Green
Mallory Billet Competition Distributor, Series Nos. 81 and 84	Orange	Purple
Mallory COMP® 9000 Series Nos. 96-99	Orange	Purple
Mallory Harness P/N 29040	Red	Black
MSD	Orange/Black	Violet/Black
MSD Crank Trigger	Orange/Black	Violet/Black
Ford	Orange	Purple
ACCEL 46/48000 Series	Orange/Black	Violet/Black
ACCEL 51/61000 Series	Red	Black
Chrysler	Orange/White	Black

## PRESTART CHECKLIST

- The only wires connected to the coil terminals should be the orange connected to coil positive (+) and black connected to coil negative (-).
- The small red wire is connected to a switched 12 volts source, such as the ignition key.
- Power leads are connected directly to the battery positive and negative terminals.
- If you're not using an alternator, the battery should be connected and fully charged.
- The engine is equipped with at least one ground strap to the chassis.

## THEFT DETERRENT

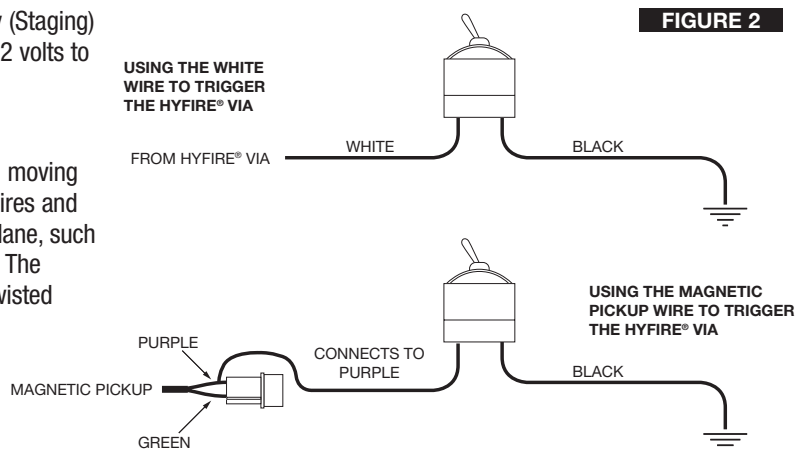
The HYFIRE® 6AL2 Ignition Control provides an easy way to install a theft deterrent kill switch. See Figure 2.

### White Wire Trigger

When using the white wire to trigger the HYFIRE® 6AL2 Ignition Control, install a switch to the white wire and the other side to ground. When the white wire is grounded, the vehicle will crank but will not start.

### Magnetic Pickup Trigger

When using the mag pickup to trigger the HYFIRE® 6AL2 Ignition Control, install a switch across the magnetic pickup violet wire to ground. When the violet wire is grounded, the vehicle will crank but will not start.



## TROUBLESHOOTING

This section offers several tests and checks you can perform to ensure proper installation and operation of the HYFIRE® 6AL2 Ignition Control. If you experience a problem with your HYFIRE® 6AL2, first check for proper installation and poor connections. You can eliminate many problems by checking these items. If you have any questions concerning your HYFIRE® 6AL2 Ignition Control contact the Mallory Technical Service Department at 216-688-8300, option 5.

### Tach/Fuel Adapters

If your tachometer does not operate correctly, you probably need a Mallory tach adapter. Consult the Tachometer Compatibility List at right for common tachometers and compatible tach adapters.

### No-Run on Foreign Vehicles

Some foreign vehicles with fuel injection systems may require a tachometer/fuel injection adapter to run with the HYFIRE® 6AL2 Ignition Control. Often, the same trigger source is used to operate an ignition, tachometer, and fuel injection. This results in a voltage signal that is too low to trigger the fuel injection. A tach/fuel injection adapter will usually solve this problem.

### Inoperative Tachometers

If your tachometer fails to operate with the HYFIRE® 6AL2 installed, you may need a Mallory tach adapter. Before purchasing a tach adapter, try connecting your tachometer trigger wire to the yellow wire of the HYFIRE® 6AL2 Ignition Control. This output produces a 12 volt, square wave. If the tach still does not operate, you will need a tach adapter. Two different tach adapters are available:

**PN 29078** If you are using the magnetic pickup connector (green and violet wires) to trigger the HYFIRE® 6AL2, you will need this adapter.

**PN 29074** If your tach was triggered from the coil negative terminal (voltage trigger) and you are using the white wire to trigger the HYFIRE® 6AL2, you will need this adapter.

### Ballast Resistor

If you have a current trigger tach (originally connected to coil (+) positive) and use the white wire of the HYFIRE® 6AL2 for triggering, you can purchase a Chrysler Dual Ballast Resistor (1973-76 applications). Wire it as shown in Figure 3.

### Engine Run-On

If your engine continues to run even when the ignition is turned off, you are experiencing engine run-on. Usually, older vehicles with an external voltage regulator are susceptible to this condition. Because the HYFIRE® 6AL2 Ignition Control receives power directly from the battery, it does not require much current to keep the unit energized. If you are experiencing run-on, it is due to a small amount of voltage going through the charging lamp indicator and feeding the small red wire (even if the key is turned off).

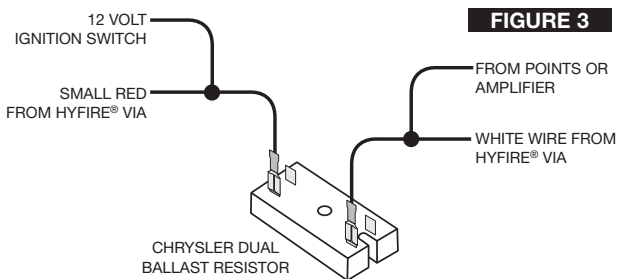


FIGURE 3

Aftermarket Tachometer	White Wire Trigger	Magnetic Trigger Connector
Autogage	29074	29078
Autometer	—	—
Ford Motorsport	—	—
Moroso	—	—
Stewart	29074	29078
S.W. & Bi Torx	—	—
Sun	29074	29078
VDO	8910	29078
AMC (Jeep)	29074	29078
Chrysler	29074	29078
Ford (Before 1976)	29074	29078
Ford (After 1976)	29074	29078
GM	Bypass in-line filter	Bypass in-line filter
Imports	29074	29078

Early Ford and GM: To solve the run-on problem, a diode is supplied with the HYFIRE® 6AL2 Ignition Control. By installing this diode in-line of the wire that goes to the charging indicator, the voltage is blocked from entering the HYFIRE® 6AL2 Ignition Control. Figure 4 shows the proper diode installation for early Ford and GM vehicles.

**NOTE: Diodes are used to allow voltage to flow only one way. Make sure the diode is installed facing the proper direction, as shown in Figure 4.**

Ford: Install the diode in-line to the wire going to the #1 terminal.  
GM: Install the diode in-line to the wire going to the #4 terminal.

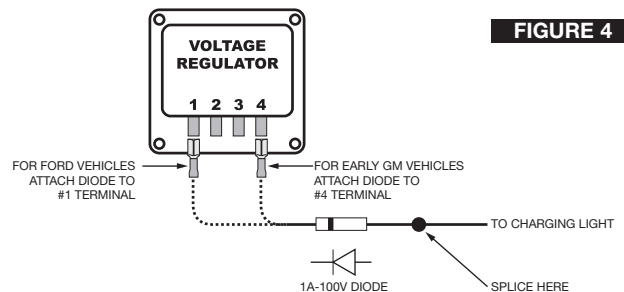


FIGURE 4

### GM 1973-83 with Delcotron Alternators

GM Delcotron alternators use an internal voltage regulator. Install the diode in-line on the smallest wire exiting the alternator (see Figure 5). It is usually a brown wire.

Most other applications: To eliminate run-on, place a resistor in-line to the HYFIRE® 6AL2 small red wire to keep voltage from leaking into the HYFIRE® 6AL2 Ignition.

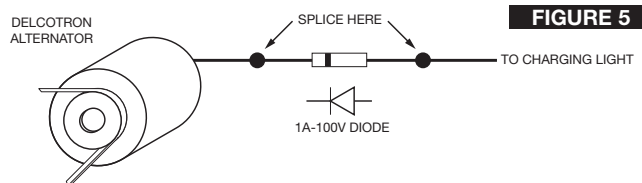


FIGURE 5



### Misses and Intermittent Problems

Experience has shown that if your engine is misfiring or hesitating at higher RPM, it is usually not an ignition problem. Most common causes include a coil or plug wire failure, arcing from the cap or boot plug to ground or spark ionization inside the cap. Perform the following checks:

- Inspect the plug wires at the cap and at the spark plug for a tight connection. Visually inspect for cuts, abrasions, or burns.
- Inspect the primary coil wire connections. Because the HYFIRE® 6AL2 Ignition Control receives a direct 12 volt source from the battery, there will not be any voltage at the coil positive (+) terminal, even with the key turned on. During cranking, or while the engine is running, very high voltage will be present and no test equipment should be connected.

**WARNING: Do not touch the coil terminals during cranking or while the engine is running.**

- Make sure that the battery is fully charged and the connections are clean and tight. If you are not running an alternator, this is an imperative check. If the battery voltage drops below 10 volts during a race, the HYFIRE® 6AL2 Ignition Control output voltage will drop.
- Is the engine running lean? Inspect the spark plugs and the entire fuel system.
- Check all wiring connections for corrosion or damage. Remember to use proper connections followed by soldering, then seal the connections completely.

If everything checks positive, use the procedure below to test the ignition for spark. Mallory also offers an Ignition Tester (PN 28357) that allows you to check the entire ignition system while it is installed in the vehicle. This tool also checks operation of RPM limits, activated switches, and shift lights.

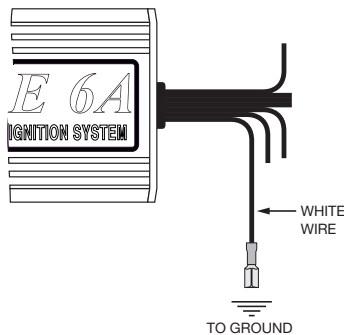


FIGURE 6

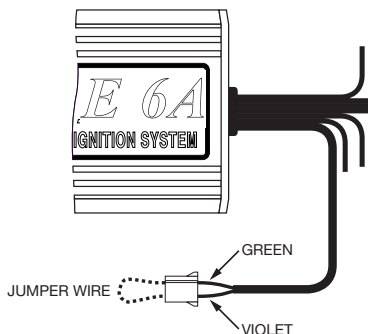


FIGURE 7

### CHECKING FOR SPARK

#### If triggering the ignition with the white wire:

(See Figure 6)

1. Make sure the ignition switch is in the "OFF" position.
2. Remove the coil wire from the distributor cap and set the terminal approximately 1/4" from ground.
3. Disconnect the HYFIRE® 6AL2 Ignition Control white wire from the distributor's points or ignition amplifier.
4. Turn the ignition to the "ON" position. Do not crank the engine.
5. Tap the white wire to ground several times. Each time you pull the wire from ground, a spark should jump from the coil wire to ground. If spark is present, the ignition is working properly. If there is no spark, skip to Step 6 below.

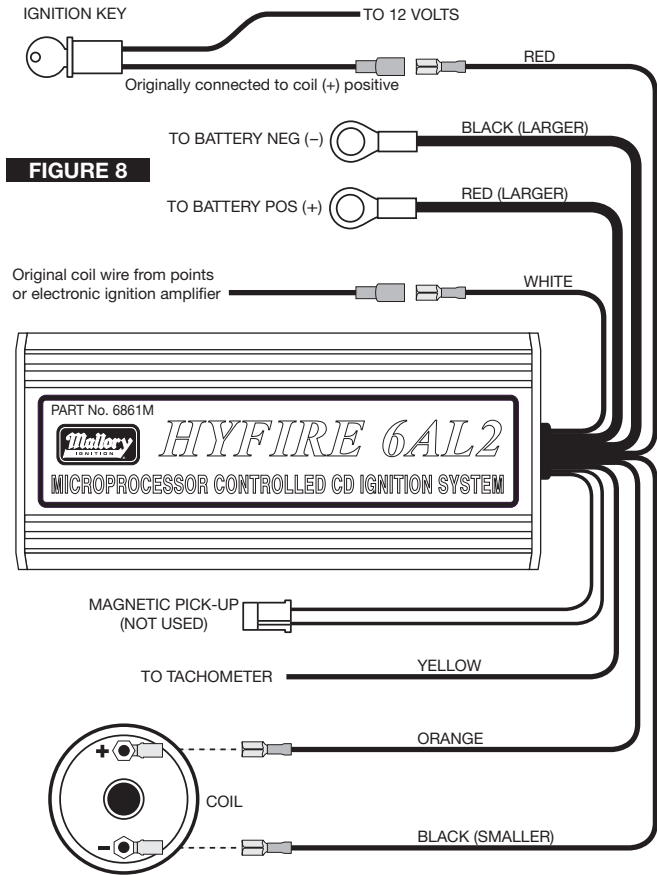
#### If Triggering With the Magnetic Pickup:

(See Figure 7)

1. Make sure the ignition switch is in the OFF position.
2. Remove the coil wire from the distributor cap and set the terminal approximately 1/4" from ground.
3. Disconnect the HYFIRE® 6AL2 Ignition Control magnetic pickup wires from the distributor.
4. Turn the ignition to the ON position. Do not crank the engine.
5. With a small jumper wire, short the HYFIRE® 6AL2 Ignition Control green and violet magnetic pickup wires together. Each time you break this short, a spark should jump from the coil wire to ground. If spark is present, the ignition is working properly. If there is no spark skip to Step 6 below.
6. If there is no spark.
  - A. Inspect all of the wiring.
  - B. Substitute another coil and repeat the test. If there is now spark, the coil is at fault.
  - C. If there is still no spark, check to make sure there is 12 volts on the small red wire from the HYFIRE® 6AL2 Ignition Control when the key is in the ON position. If 12 volts is not present, find another switched 12 volts source and repeat the test.
  - D. If, after following the test procedures and inspecting all of the wiring, there is still no spark, the HYFIRE® 6AL2 Ignition Control is in need of repair. See the Warranty and Service section for information.

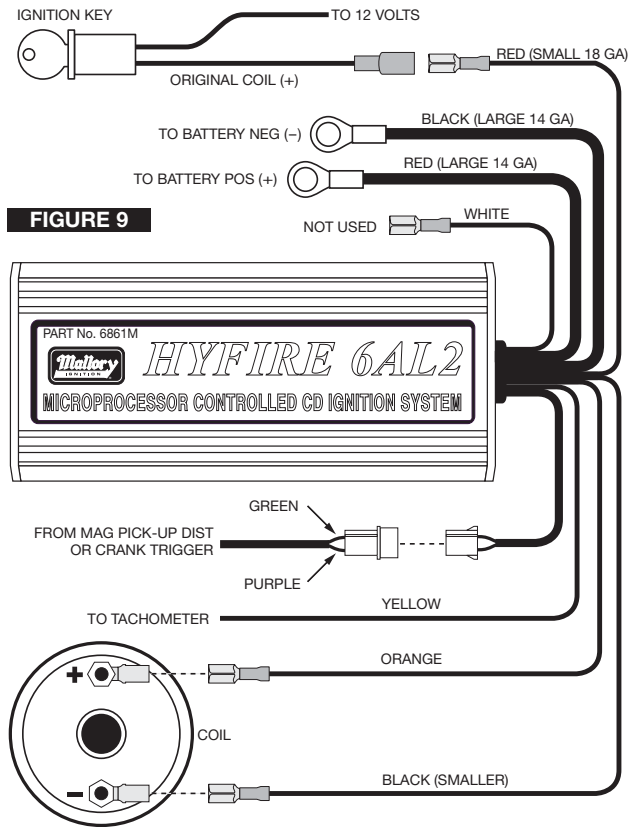
**The illustrations on the following pages show the best way to install the HYFIRE® 6AL2 Ignition Control on various applications. If you have any problems or questions while installing this device on your vehicle, contact the Mallory Technical Service Department at (216) 688-8300, 8:00 AM to 5:00 PM EST, or email [tech@mrgasket.com](mailto:tech@mrgasket.com).**

### Installing the HYFIRE® 6AL2 with a Points/Amplifier Style Ignition



**FIGURE 8**

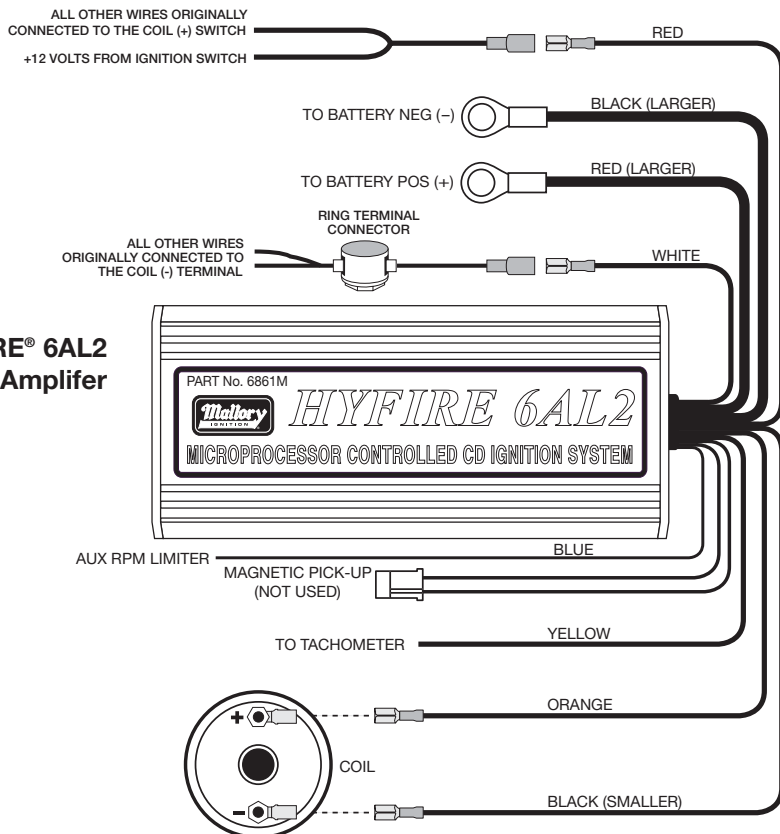
### Installing the HYFIRE® 6AL2 with a Magnetic Pickup Distributor or Crank Trigger

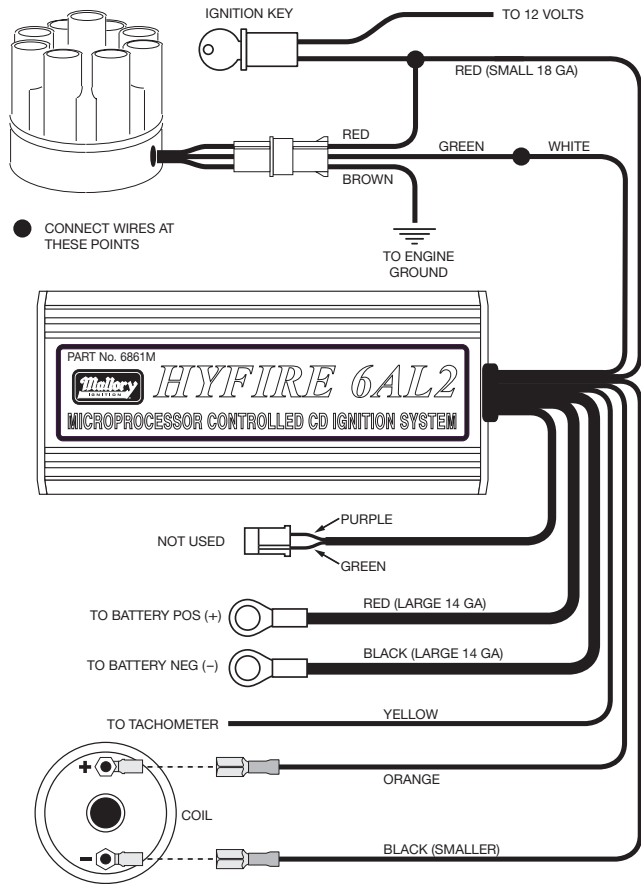


**FIGURE 9**

### Installing the HYFIRE® 6AL2 with an OEM Ignition Amplifier

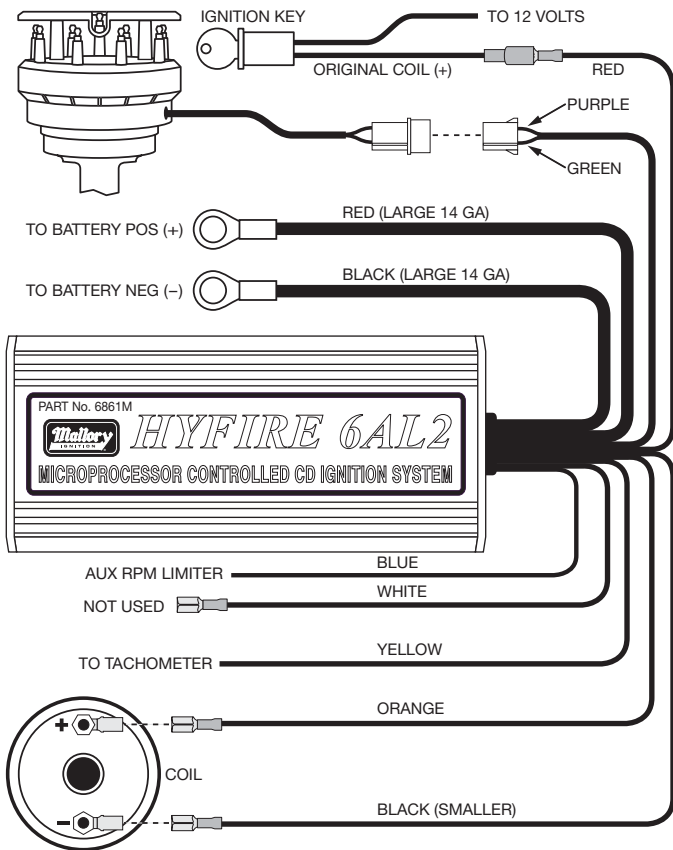
**FIGURE 10**





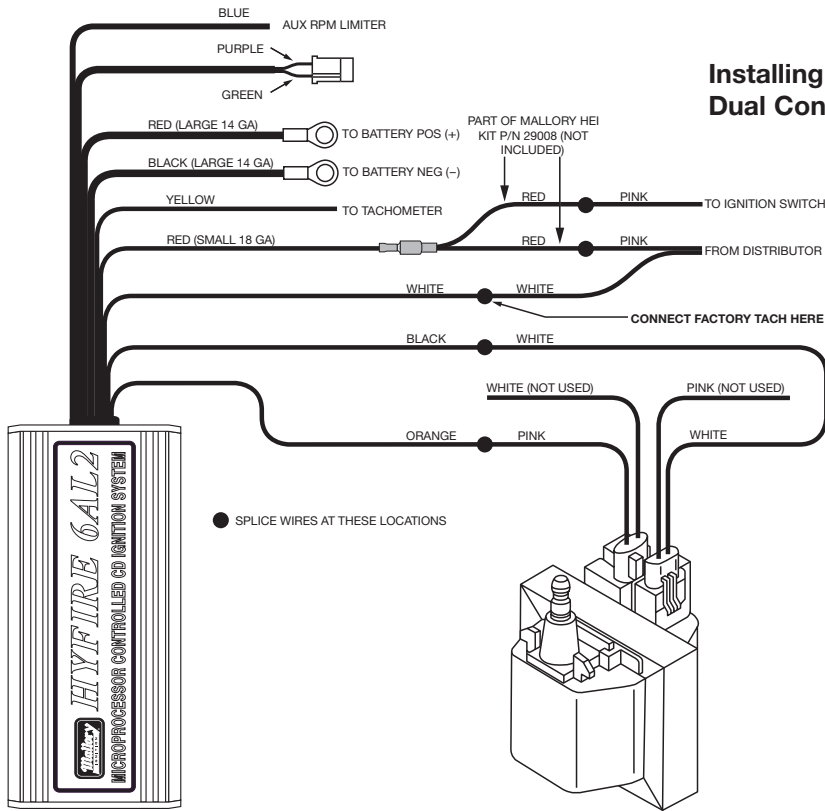
**FIGURE 11**

Installing the HYFIRE® 6AL2 with a Mallory UNILITE® or Magnetic Breakerless Distributor



**FIGURE 12**

Installing the HYFIRE® 6AL2 with a Mallory 81-84 Series Distributor (2-Wire Magnetic Pickup)

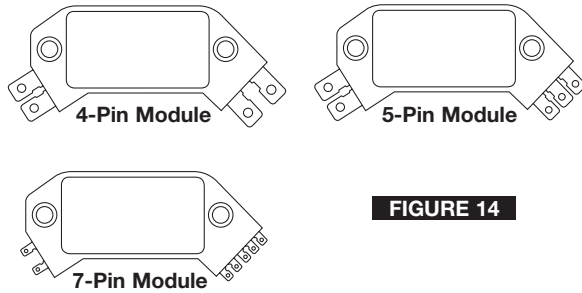


### Installing the HYFIRE® 6AL2 with a Dual Connector Coil HEI System

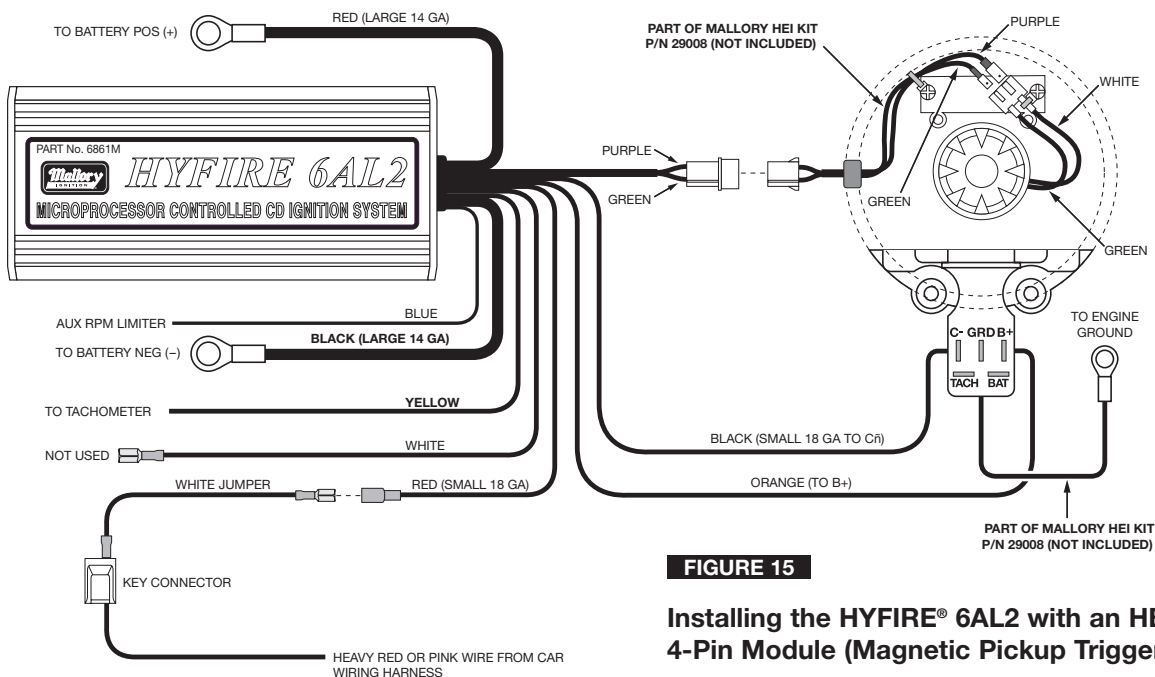
**FIGURE 13**

There are three different large cap HEI distributors. To identify which of the following diagrams fit your specific application, remove the distributor cap and rotor and locate the ignition module at the base of the distributor. Count the number of terminals on both ends of the module and follow the corresponding diagram. GM used 4, 5, and 7-pin modules in these distributors.

**NOTE:** Some 5-pin modules may experience a hesitation or stall on deceleration. If this occurs, contact the Mallory Technical Service Department for the required bolt-in diode to correct the problem.



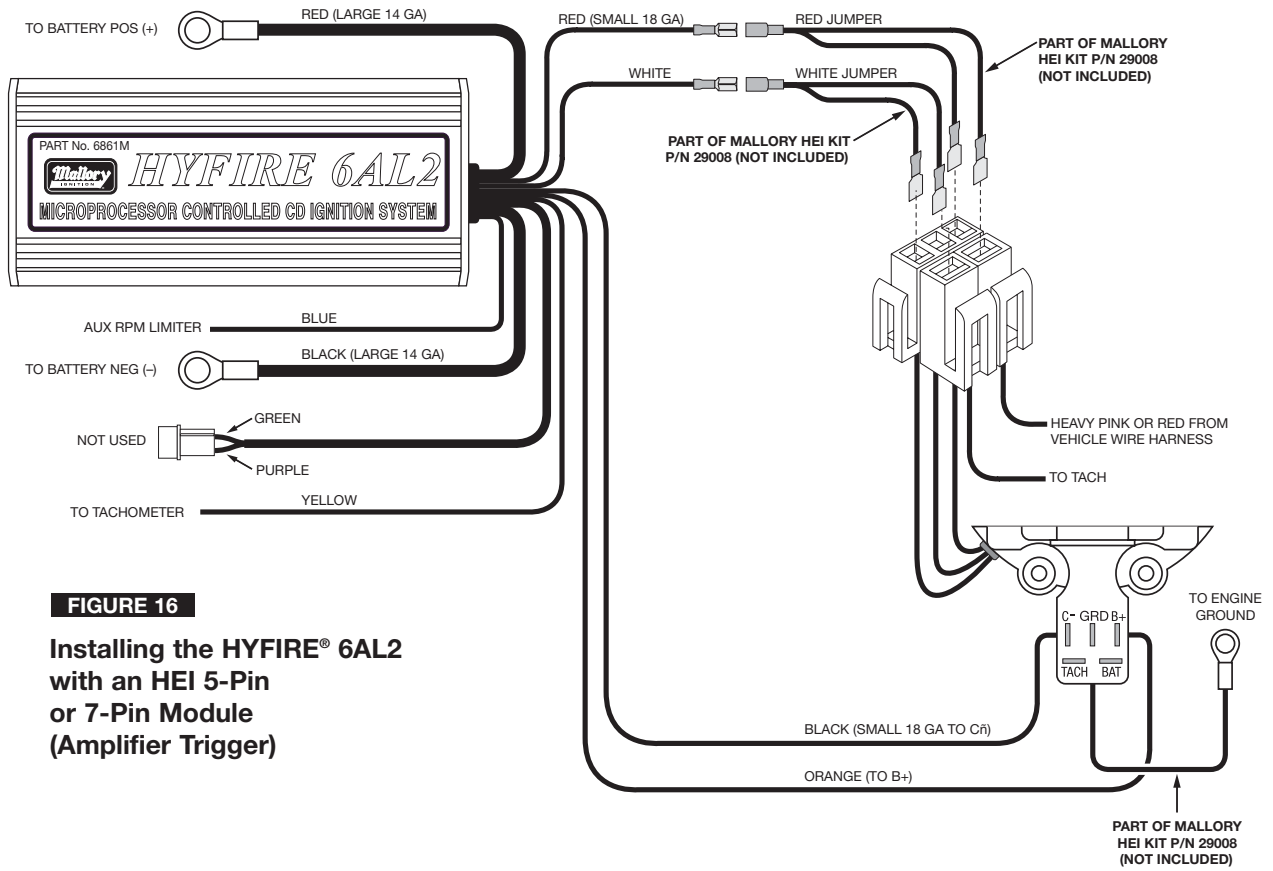
**FIGURE 14**



**FIGURE 15**

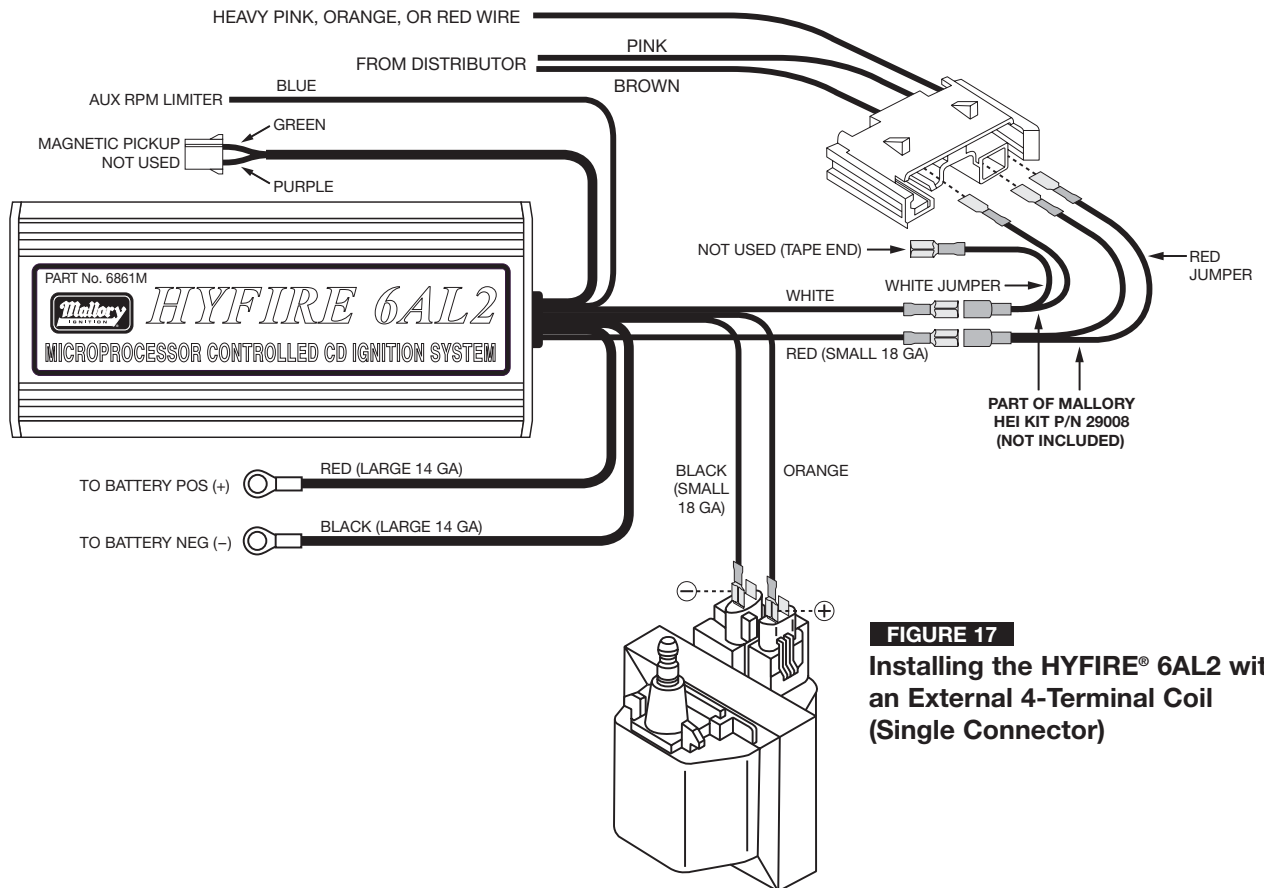
### Installing the HYFIRE® 6AL2 with an HEI 4-Pin Module (Magnetic Pickup Trigger)





**FIGURE 16**

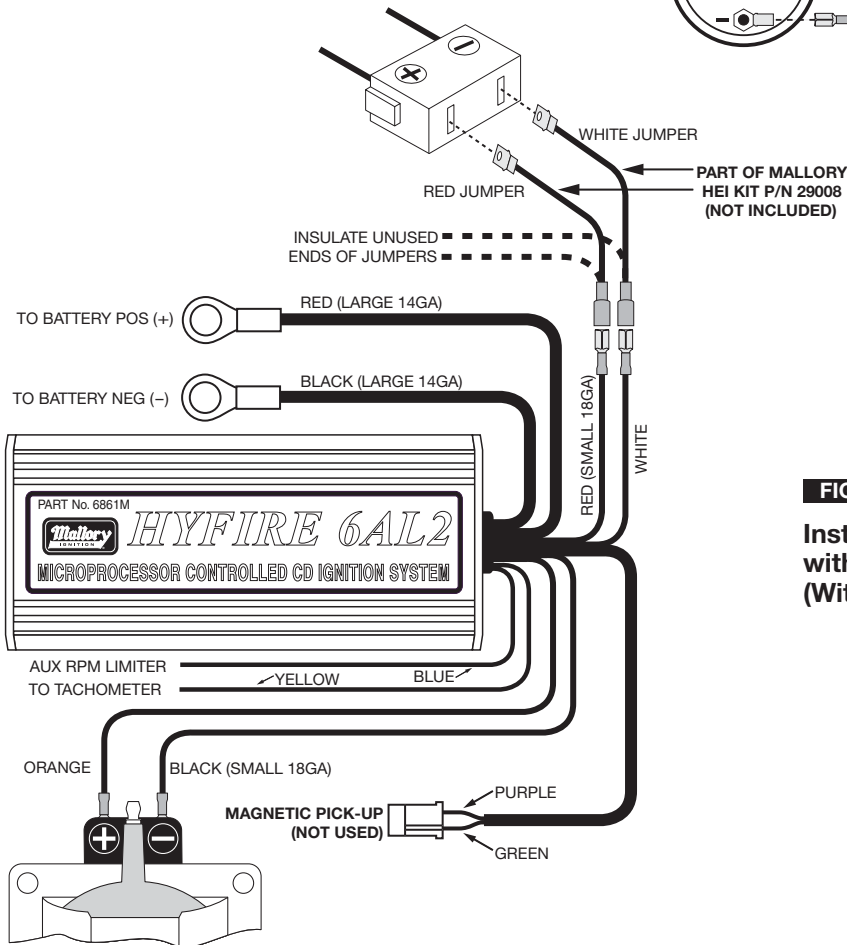
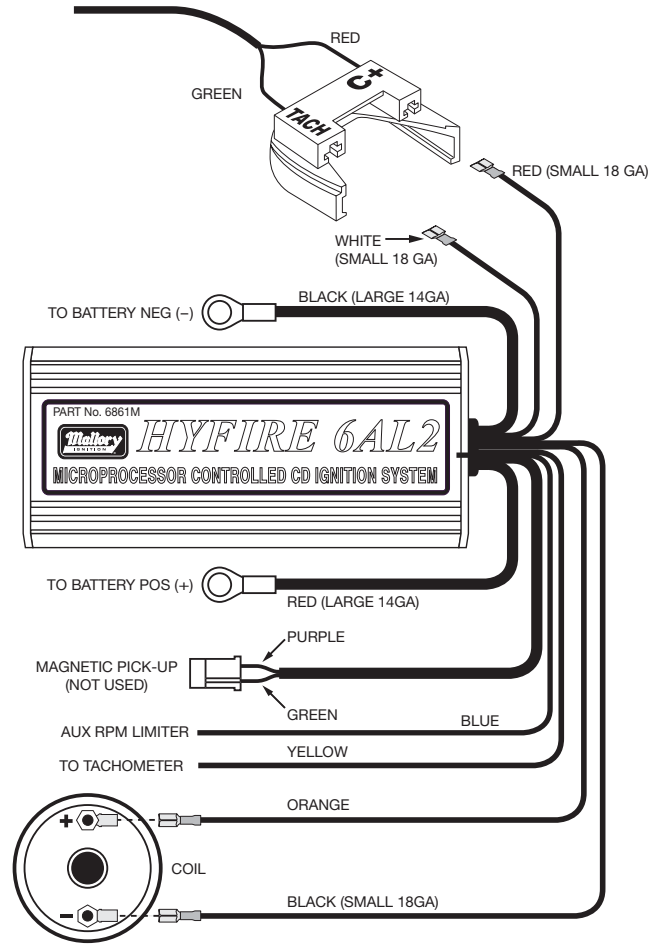
**Installing the HYFIRE® 6AL2 with an HEI 5-Pin or 7-Pin Module (Amplifier Trigger)**



**FIGURE 17**

**Installing the HYFIRE® 6AL2 with an External 4-Terminal Coil (Single Connector)**

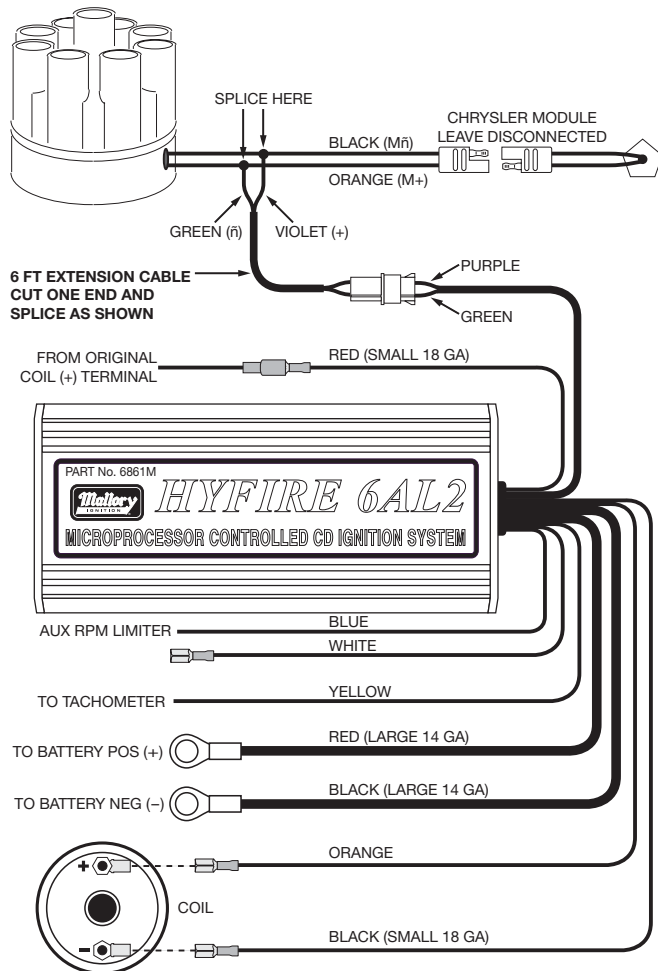
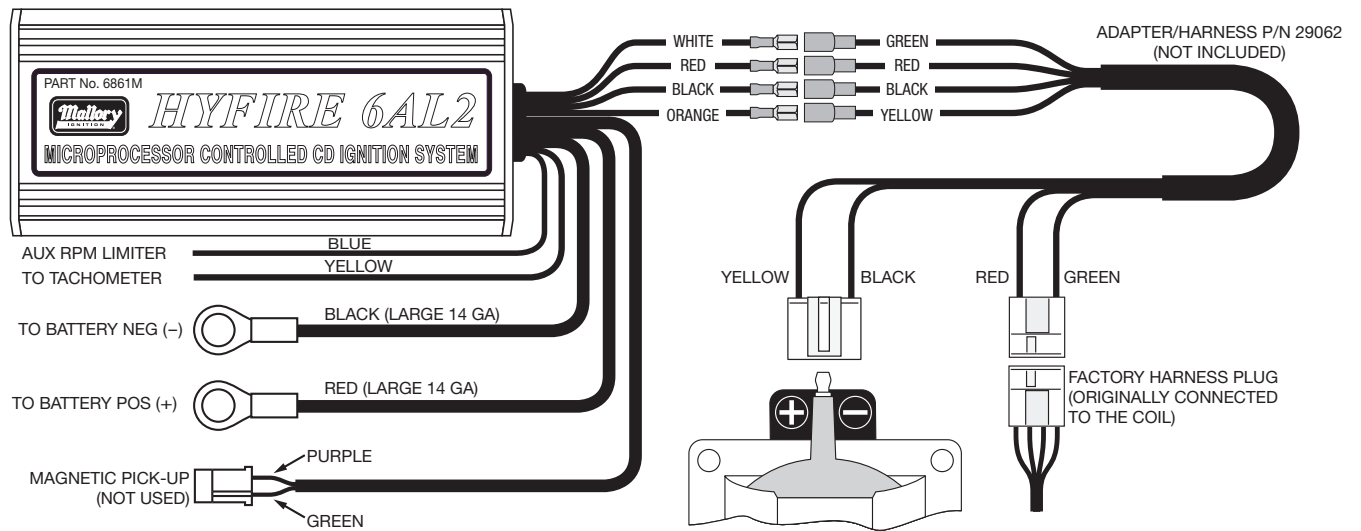
**FIGURE 18**  
**Installing the HYFIRE® 6AL2 with a Ford Duraspark using the White Wire Trigger**



**FIGURE 19**  
**Installing the HYFIRE® 6AL2 with a Ford TFI (Without Harness)**

**FIGURE 20**

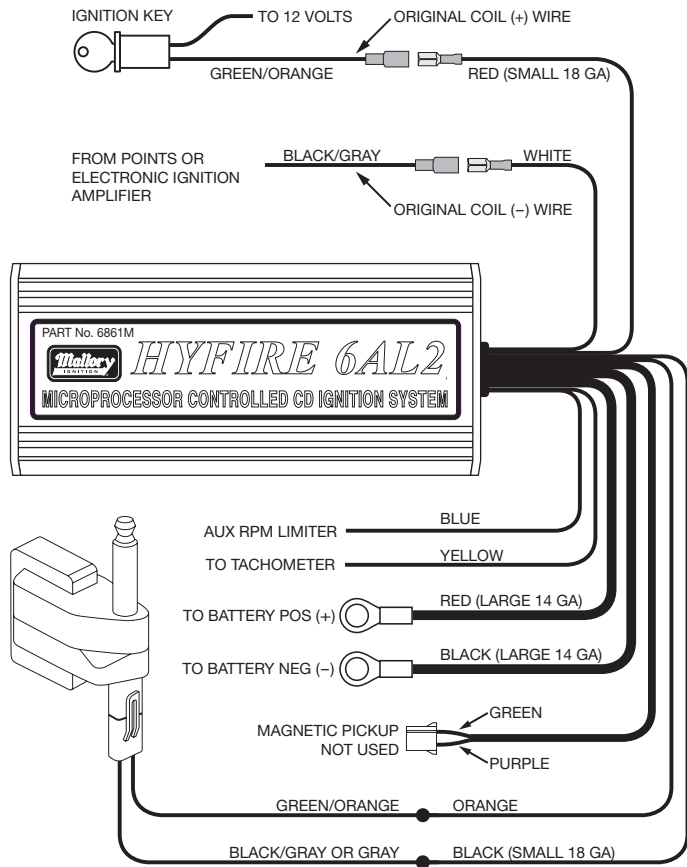
**Installing the HYFIRE® 6AL2 with a Ford TFI (With Harness)**



**FIGURE 21**

**Installing the HYFIRE® 6AL2 with a Chrysler Electronic Ignition using a Magnetic Pickup Trigger**

**FIGURE 22**  
**Installing the HYFIRE® 6AL2 with a Late Model Dodge (with 2-Pin Connector)**



**FIGURE 23**  
**Installing the HYFIRE® 6AL2 with a Typical Import Application**

