



## INSTALLATION INSTRUCTIONS

# HYFIRE® IV SERIES OF ELECTRONIC IGNITION CONTROLS

## HYFIRE® IVc Ignition System Part No. 692, Universal HYFIRE® IVA Ignition System Part No. 697, Universal

For applications triggered by points, Mallory Electronic Ignition Distributor (all models), original equipment electronic ignition amplifiers and magnetic trigger pulses (magnetic pickup distributor or crank trigger ignition). Optional adapters are available for easy connection to early model Delco/GM HEI Systems, late model GM HEI/EST Systems, Ford TFI Systems, and OEM magnetic pickup (non-computer; Ford DuraSpark, GM HEI and Mopar/Chrysler Electronic Systems).

*This product is legal to sell, distribute or install on vehicles in California. C.A.R.B. Executive Order D-70-26.*

**NOTE:** Mallory HYFIRE® IV Electronic Ignition Controls are not compatible with distributorless systems or positive ground applications. The RPM Limiter in the HYFIRE® IVC (Part No. 692) will not work properly with odd-fire or semi-even fire V6 applications.

### Parts included in this kit:

1	HYFIRE® IV Electronic Ignition Control - Part No. 692 or 697	8	Ring Terminals, 1/4"
1	Ignition Control Harness - Part No. 29348	1	Ring Terminal, 3/8"
2	Terminal Connectors - Part No. 450	5	Spade Receptacle Terminals
1	Bypass Connector	4	Mounting Brackets
4	Cable Ties	4	#10 Sheet Metal Screws
2	Spade Terminals		

## CONTENTS

General Information .....	2	Ford DuraSpark Systems (non-computer type, without module) .....	5-6
Ignition Ballast Resistor/Loom Resistance Wire .....	2	Early Model GM HEI Systems (non-computer type, without module) .....	6, 8
Standard Ignition Bypass (Bypass Connector) .....	2	Mopar/Chrysler Corp. Electronic Systems (non-computer type, without module) .....	6, 9
Ignition Coils .....	2	Wiring Method Without Adapters .....	7
Fuel Injection .....	2	Breaker Point Systems .....	7, 9
Spark Plug Wires .....	2	Mallory Electronic Ignition, UNILITE® Distributors, Magnetic Breakerless Distributors or Electronic Advance Distributors (3-wire/red, brown, green) .....	7, 10
Spark Plug Gaps .....	2	For OEM Electronic Systems with modules/amplifiers (Chrysler, Ford, and import) .....	7, 10
Electric Welding .....	2	Magnetic Pickup Trigger Pulses (magnetic pickup distributors or crank trigger ignition) .....	7, 10
External RPM Limiters		RPM Limiter Operation – HYFIRE® IVC Ignition System (PN 692 only) .....	11
Mallory PRO TACH® I, IV and VI .....	2	Optional Ignition Accessories .....	11
HYFIRE® IVC Ignition System – 4 and 6 Cylinder Operation .....	2	Bypass Connector .....	12
Mounting Procedure .....	2	Mounting Template .....	12
Mounting to a Flat Surface Without Mounting Brackets .....	2		
Mounting to a Flat or Uneven Surface			
Using Mounting Brackets .....	2		
Mounting to a Flat Surface with Shock Mounts .....	2		
Wiring Procedure .....	3		
Wiring Method using Adapters and Harnesses .....	3		
GM HEI Systems/coil-in-cap with OEM module) .....	3-4		
Late Model GM HEI/EST Systems (external coil) .....	3-5		
Ford TFI Systems .....	4, 6		

## GENERAL INFORMATION

**The HYFIRE® IV Ignition System Part Nos. 692 and 697 are not for marine use.**

The RPM limiter in the HYFIRE® IVC is not recommended as an engine speed governor. The use of the RPM limiters is not recommended for applications equipped with a catalytic converter. Similarly, forcing engine RPM past the RPM limiter continuously for long sustained intervals can cause fuel build up in the exhaust system that may adversely affect your application. The RPM limiting systems will not work properly with odd-fire V6 applications.

### Ignition Ballast Resistor / Loom Resistance Wire

The performance of the HYFIRE® IV is not affected by the presence of the factory ignition resistors or ignition ballast resistors in the wire from the ignition switch.

### Standard Ignition Bypass (Bypass Connector)

The Bypass Connector (supplied) fits into the Ignition Control Harness to convert back to standard ignition. If you use the Bypass Connector, use ignition ballast resistors designed for your vehicle's distributor and coil (see diagrams for more information). This bypass method does not work with magnetic pickup distributor or crank trigger ignition. Racing Applications: It is not necessary to install ignition ballast resistors. However, do not use the Bypass Connector until the ignition ballast resistors are installed in the wire from the ignition switch.

### Ignition Coils

The HYFIRE® IV Electronic Ignition Controls are designed to work with most original equipment ignition coils. For optimum performance use the Mallory PROMASTER® Coil Part No. 29440 (up to 7,500 RPM) or Part No. 29625 (up to 10,000 RPM).

### Fuel Injection

Some fuel injection systems need a voltage spike signal from the ignition coil before it will operate properly. This signal changes once HYFIRE® IV Electronic Ignition Controls are installed. The Mallory Fuel Injection and Tachometer Adapters Part Nos. 29074 and 29078 supply the proper signal to the vehicle computer to operate the fuel injection system. Installation procedure and diagrams are supplied with these adapters.

### Spark Plug Wires

YOU MUST USE suppression type (carbon core, spiral core, suppression core) spark plug wire. We recommend spiral core ignition wire, such as Mallory PRO SIDEWINDER® Ignition Wire. Suppression type spark plug wires prevent false triggering and possible premature ignition or accessory failures. **DO NOT USE solid core (copper core; stainless steel core) spark plug wire with any electronic ignition system or accessory.**

### Spark Plug Gaps

For street applications, use your engine manufacturer's specifications. For racing applications, start with your engine manufacturer's specifications, then experiment with, and closely monitor, various gaps to achieve maximum performance.

### Electric Welding

Unplug the Ignition Control Harness from the HYFIRE® IV Electronic Ignition Control and unplug any distributor harnesses (if possible) before any welding is done on the vehicle.

### External RPM Limiters

Mallory Proportional RPM Limiter Part Nos. 641-4, 641-6, 641-8, 642, 643 and 644 WILL NOT function with the HYFIRE® IV Electronic Ignition Controls.

### Mallory PRO TACH® I, IV and VI

The RPM needle and shift light will work with the HYFIRE® IV. However, the tach's proportional controller that limits RPM WILL NOT function with the HYFIRE® IV. Turn the LIMIT RPM knob slightly past 11,000 to prevent the limiter from interfering with the tach's other functions. See Optional Ignition Accessories for more information.

## HYFIRE® IVC IGNITION SYSTEM

### 4 AND 6 CYLINDER OPERATION

The HYFIRE® IVC Ignition System comes from the factory set for 8 cylinder engines. 4 or 6 cylinder operations require you to set a switch inside the housing. **DO THIS BEFORE MOUNTING THE IGNITION BOX!**

- Use a T-15 Torx® tool to remove the four screws that holds the blank end panel to the housing. Remove the blank end panel (see Figure 1).
- With the ignition upside-down, look inside and on the left side of the PC board you will see a small two position switch. The switch (#1) nearest the end of the PC board is the 6 cylinder switch. The other switch (#2) is the 4 cylinder switch. These switches are OFF for 8 cylinder engines. Turn the appropriate switch ON for 4 or 6 cylinder operations.
- Attach the blank end panel to the housing.

## MOUNTING PROCEDURE

### Step 1

Disconnect the battery (-) cable to cut power to the system. Computerized vehicles: Disconnect the battery (-) cable and let the vehicle sit overnight before proceeding. This allows the computer to calibrate for the new ignition.

### Step 2

Select a convenient location to mount the HYFIRE® IV Electronic Ignition Control. Keep the unit away from hot engine components or extreme heat such as the exhaust system and manifolds. Also, keep it away from moving devices, such as fans, belts and linkages. The location must be dry. Moisture will damage components inside the unit.

### Step 3

Choose one mounting method listed below for mounting the HYFIRE® IV Electronic Ignition Control (3a, 3b, or 3c).

#### (3a) Mounting to a flat surface without brackets

- Center punch the mounting pattern on the mounting surface using the mounting template to mark locations for drilling mounting holes. Drill holes using a 7/32" drill bit.
- Hold the HYFIRE® IV Electronic Ignition Control in position over the mounting holes.
- From the backside of the mounting surface, insert the 10-32 screws with lock washers through the mounting holes and into the tapped holes in the bottom plate of HYFIRE® IV Electronic Ignition Control. Tighten each screw until snug.

#### (3b) Mounting to a flat or uneven surface using brackets Refer to Figure 2 while performing the following steps.

- Position one hole of each bracket over each tapped hole in the bottom plate of the HYFIRE® IV. Insert 10-32 screws with lock washers through these holes and into the tapped hole in the bottom plate of the HYFIRE® IV. Tighten each screw until snug.
- Hold the HYFIRE® IV in position where it will be mounted. Bend the brackets slightly to meet uneven surfaces. Center punch the mounting pattern on the mounting surface to mark locations for drilling mounting holes. Drill holes using a 9/64" drill bit.
- Insert the #10 sheet metal screws through the remaining holes in the mounting brackets and into the holes in the mounting surface. Tighten each screw until snug.

#### (3c) Mounting to a flat surface with shock mounts (available separately)

- Center punch the mounting pattern on the mounting surface using the mounting template to mark locations for drilling mounting holes. Drill holes using a 7/32" drill bit.
- Install the shock mounts into the bottom plate of the HYFIRE® IV. Hold the unit in position where it will be mounted.
- From the backside of the mounting surface, insert the 10-32 nuts with lock washers onto the shock mount studs. Tighten each nut until snug.

**FIGURE 1**

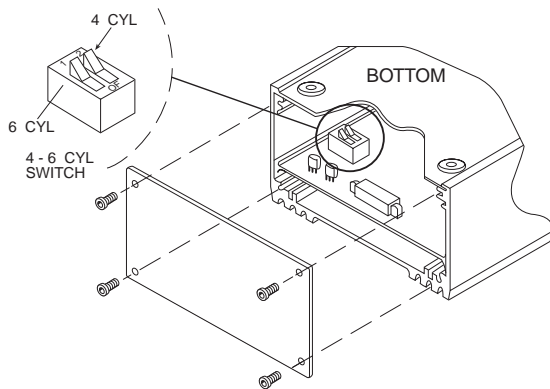

**FIGURE 2**

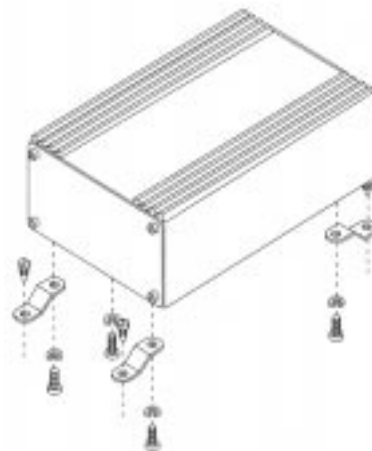

# WIRING PROCEDURE

## Step 1

### Refer to Figure 3

Ensure that your vehicle is equipped with a ground cable between the engine block and firewall (10 gauge or larger is required). Locate one LONG RED WIRE and one LONG BLACK WIRE at the end plate of the HYFIRE® IV Electronic Ignition Control.

- Connect the LONG RED WIRE to the battery (+) post or battery (+) terminal on the starter solenoid.
- Connect the LONG BLACK WIRE to engine ground or chassis ground.
- Connect the Ignition Control Harness to the Ignition Control Plug at the end plate of the HYFIRE® IV Electronic Ignition Control.

## Step 2

Choose one method listed below for wiring the HYFIRE® IV Electronic Ignition Control (2a, 2b, or 2c)

### (2a) Wiring method using Adapters and Harnesses (sold separately)

Special Wiring Adapters and Harnesses simplify the installation of the HYFIRE® IV Electronic Ignition Control into newer vehicles. These adapters and harnesses allow you to connect the HYFIRE® IV Electronic Ignition Control between the ignition coil and the factory coil connector. They reduce installation time and wiring errors. Also, converting back to the factory ignition is easy because there is no need to cut the original wiring. These instructions cover:

**PART NO. 29042** – Connecting to GM HEI Systems (coil-in-cap, with OEM ignition module)

**PART NO. 29068** – Connecting to Late Model GM HEI/EST Systems (external coil)

**PART NO. 29062** – Connecting to Ford TFI Systems.

**PART NOS. 29039 and 29040** – Connecting to Ford DuraSpark Systems (non-computer type, without ignition module).

**PART NOS. 29040 and 29043** – Connecting to Early Model GM HEI Systems (non-computer type, without ignition module)

**PART NO. 29040** – Connecting to Mopar/Chrysler Electronic Systems (non-computer type, without ignition module).

**Connecting to: GM HEI Systems (coil-in-cap, with OEM ignition module), use Adapter PART NO. 29042; Late Model GM HEI/EST Systems, use Adapter PART NO. 29068; Ford TFI Systems, use Adapter PART NO. 29062.**

### Connecting Adapter PART NO. 29042, 29062 or 29068

Refer to Figures 4, 5, and 8 when connecting to GM HEI Systems; Figure 6 when connecting to Late Model GM HEI/EST Systems; Figure 7 when connecting to Ford TFI Systems.

- Match wires by color from the Adapter to the Ignition Control Harness. Crimp all wires together.
- Disconnect the factory harness(es) at the ignition coil. Connect them to the Adapter that has the RED and GREEN WIRES.
- Connect the Adapter that has the YELLOW and BLACK WIRES to the ignition coil. NOTE: When using an aftermarket ignition coil with post type terminals, discard the Adapter that has the YELLOW and BLACK WIRES. Install ring terminals on the Ignition Control Harness YELLOW and BLACK WIRES. Connect the YELLOW WIRE to the ignition coil (+) terminal. DO NOT allow any wire except the YELLOW WIRE to make contact with the ignition coil (+) terminal. Connect the BLACK WIRE to the ignition coil (-) terminal.
- Go to Step 3, page 9.

**FIGURE 3**

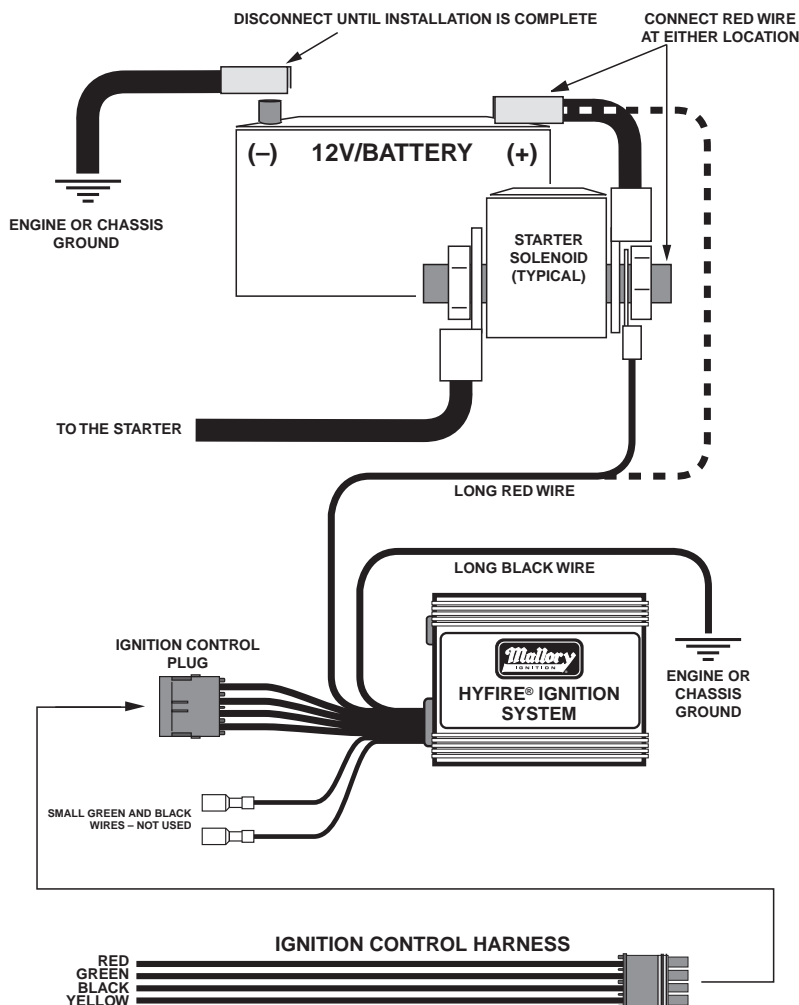

**FIGURE 4**

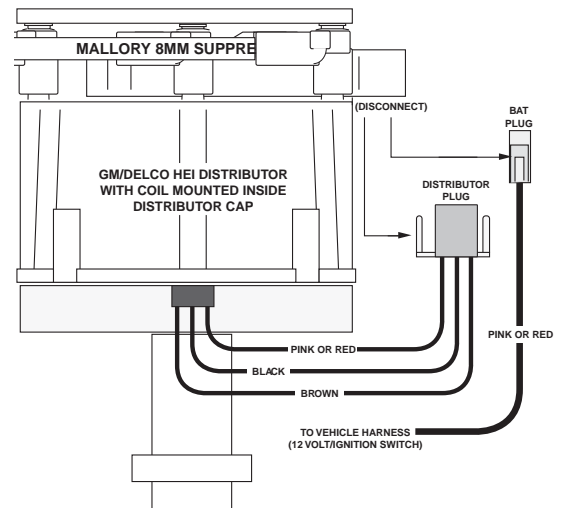

**FIGURE 5**

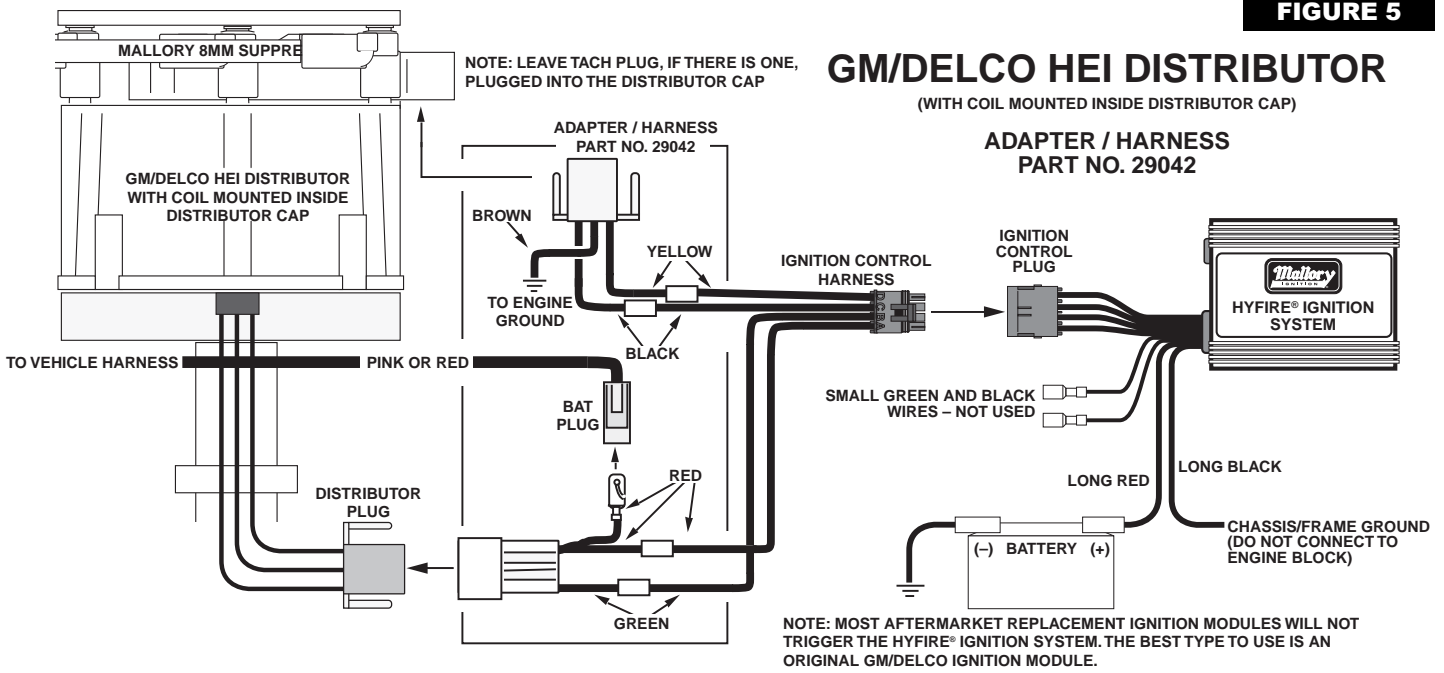

**FIGURE 6**

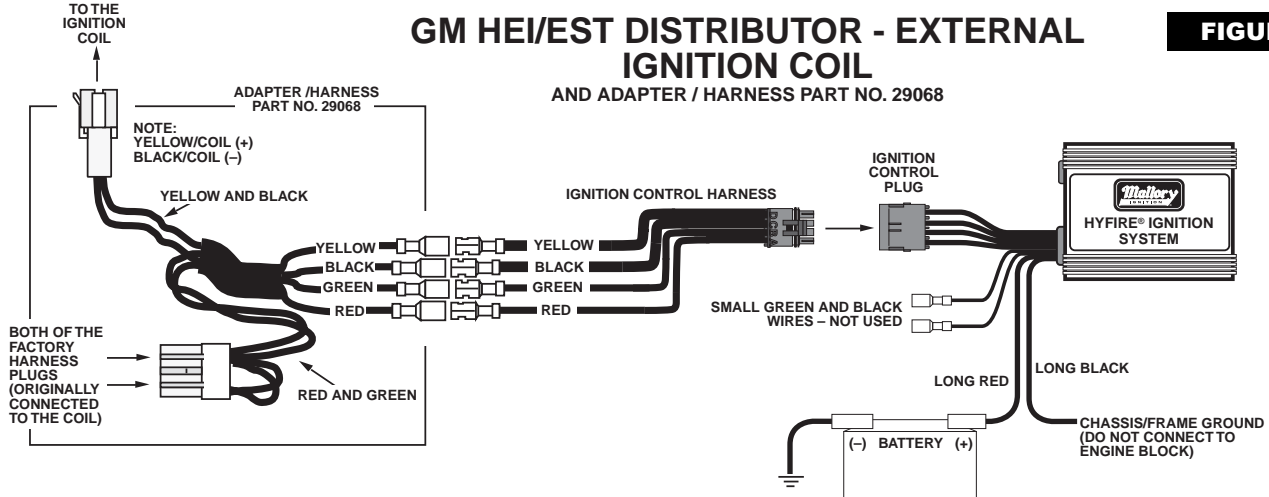

**FIGURE 7**

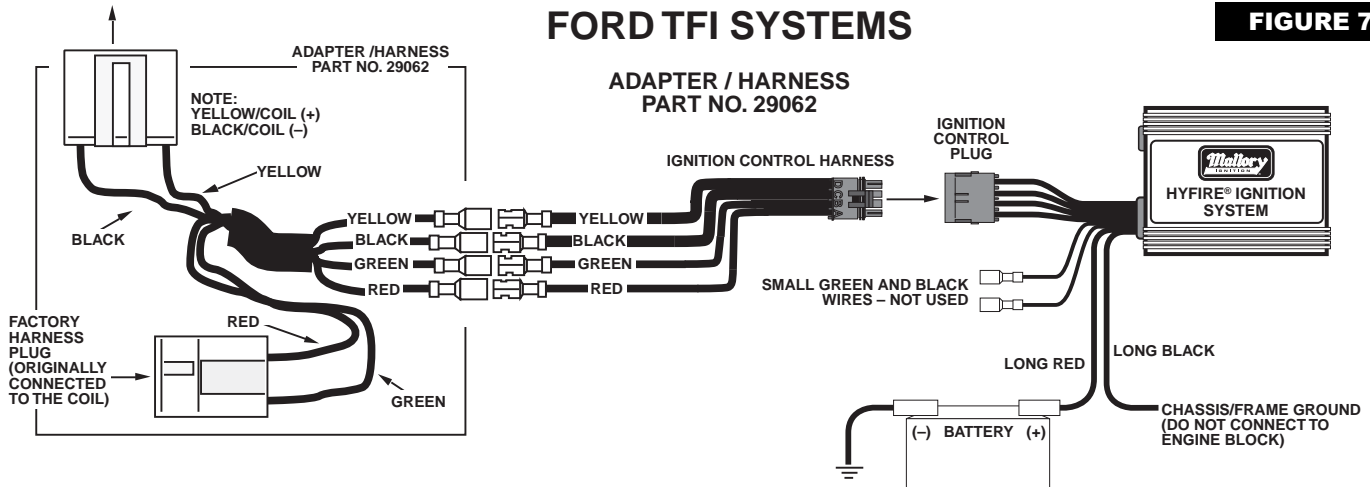
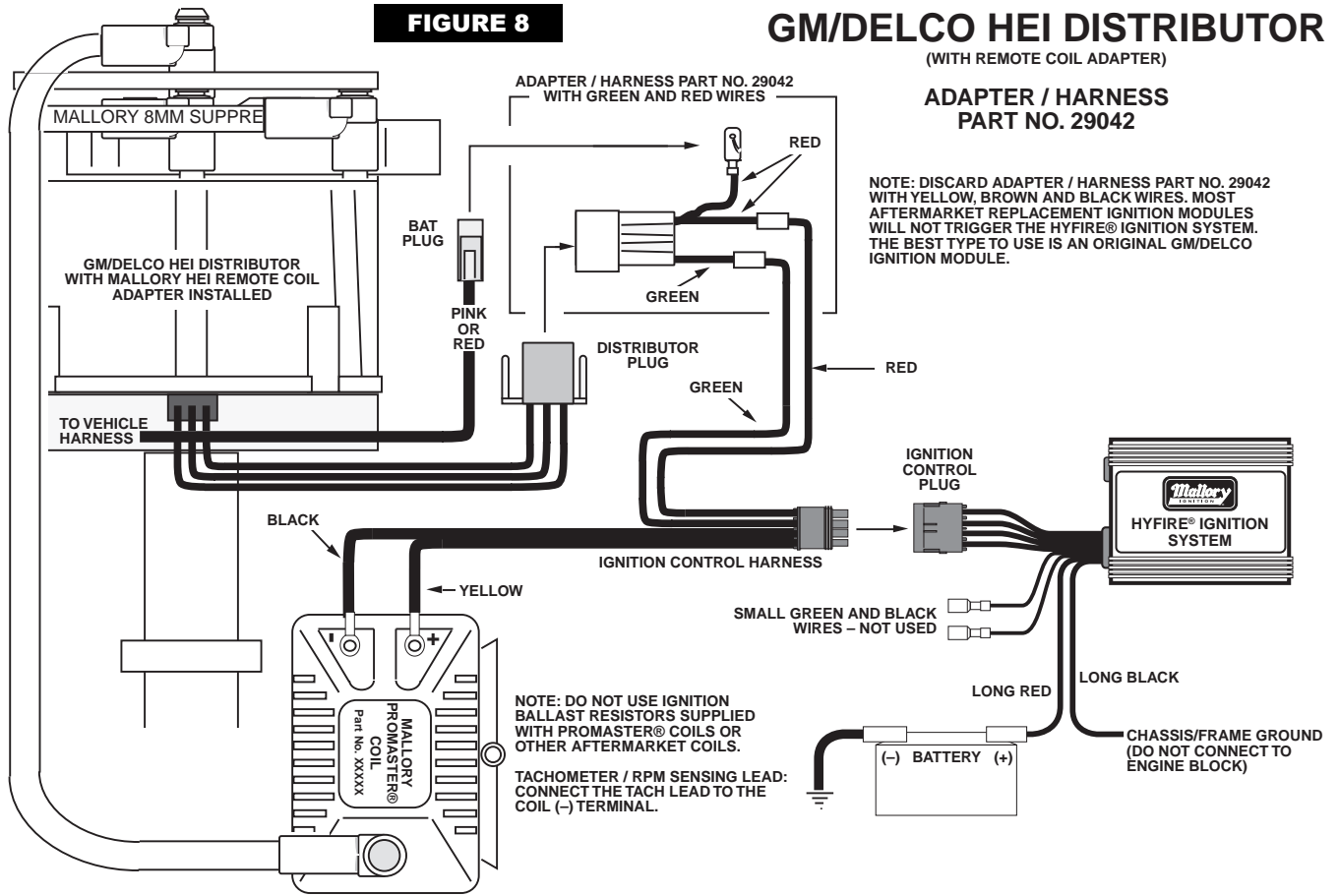

**FIGURE 8**

# GM/DELCO HEI DISTRIBUTOR

(WITH REMOTE COIL ADAPTER)

**ADAPTER / HARNESS  
PART NO. 29042**



**FIGURE 9**

# FORD AND AMERICAN MOTORS

MOTORCRAFT DURASPARK (SSI, I AND II),  
MALLORY 85 SERIES DISTRIBUTOR ADAPTER  
PART NOS. 29039 AND 29040

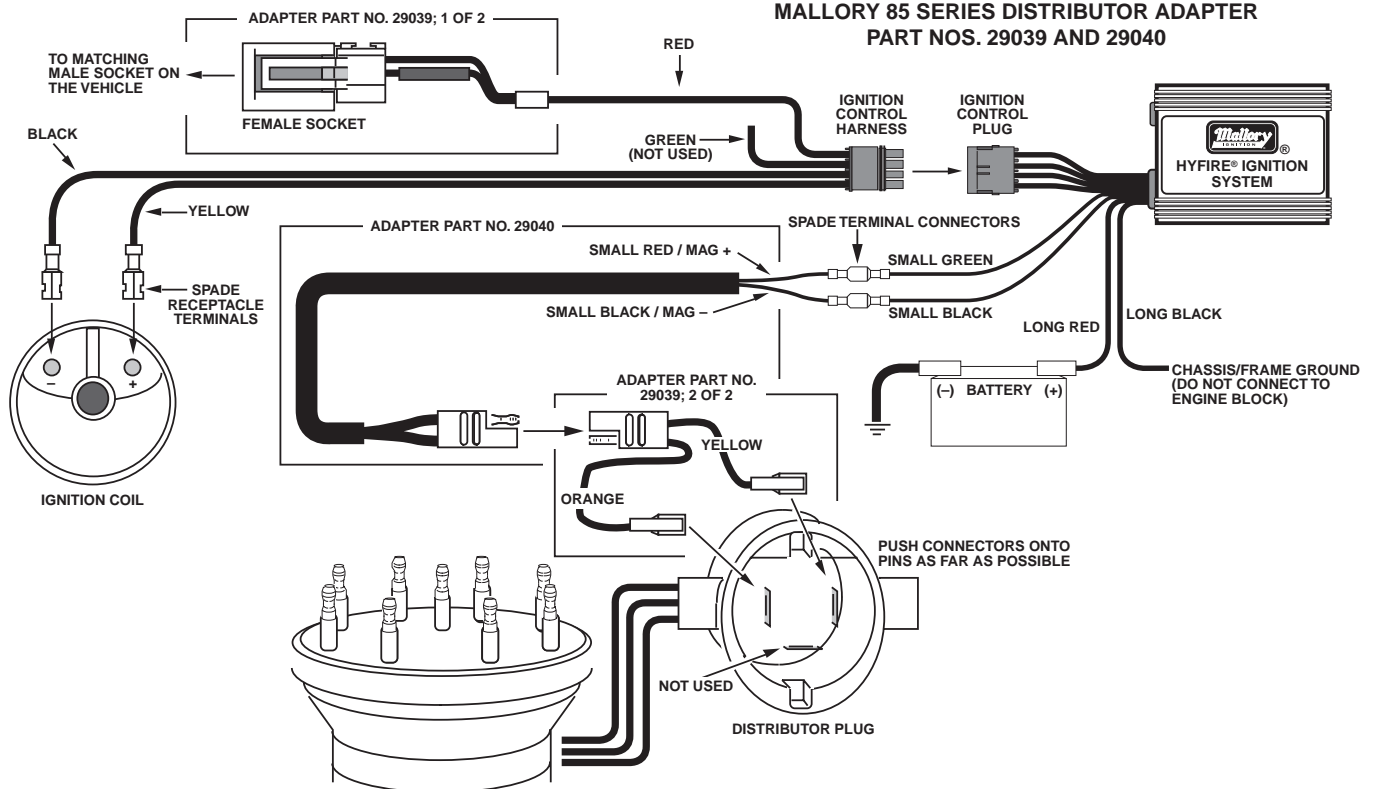

**Connecting to Ford DuraSpark Systems (non-computer type) using Adapter PART NO. 29039 and Harness PART NO. 29040 for OEM magnetic pickup**

Refer to Figure 9 while performing the following steps.

**Connecting Adapter PART NO. 29039:**

- Disconnect all connectors at the ignition module, ignition coil and distributor. Remove the ignition module. Remove the distributor and coil harnesses.
- Connect the Adapter ORANGE WIRE to the distributor plug's ORANGE WIRE.
- Connect the Adapter YELLOW WIRE to the distributor plug's PURPLE WIRE.
- Connect the other Adapter female socket to the vehicle's matching male socket. (The matching male socket was originally connected the ignition module.)

**Connecting the Harness PART NO. 29040:**

- Connect the HYFIRE® IV Electronic Ignition Control's SMALL GREEN WIRE to the Harness RED WIRE.
- Connect the HYFIRE® IV Electronic Ignition Control's SMALL BLACK WIRE to the Harness BLACK WIRE.
- Connect the mating plug of the Harness to the mating plug of the Adapter Part No. 29039 from the distributor.

**Connecting the Ignition Control Harness:**

- Route the Ignition Control Harness to the coil so that its wires do not make contact with extreme heat, sharp objects or moving devices such as fans, belts and linkages.
- Crimp the Ignition Control Harness RED WIRE to the slice connector on the Adapter Part No. 29039 female socket.
- Crimp a spade receptacle terminal on the Ignition Control Harness YELLOW WIRE. Connect the YELLOW WIRE to the ignition coil (+) terminal. DO NOT allow any wire except the YELLOW WIRE to make contact with the coil (+) terminal.
- Crimp a spade receptacle terminal on the Ignition Control Harness BLACK WIRE. Connect the BLACK WIRE to the ignition coil (-) terminal.
- NOTE: Do not connect the GREEN WIRE of the Ignition Control Harness to anything. Tape the end of the wire to insulate it.
- Go to Step 3, page 9.

**Connecting to Early Model GM HEI Systems (non-computer type) using Adapter PART NO. 29043 and Harness PART NO. 29040 for OEM magnetic pick-up. Refer to Figures 11 and 12 while performing the following steps.**

**Connecting Adapter PART NO. 29043:**

**For coil-in-cap distributors only**

- Disconnect the (RED or PINK) BAT PLUG/wire from the distributor cap.
- Disconnect the tachometer wire from the TACH terminal on the distributor cap.
- Disconnect the distributor plug from the distributor cap. For coil-in-cap distributors and external coil
- Remove the distributor cap.
- Disconnect the pickup plug from the ignition module.
- Remove the ignition module, radio noise filter/capacitor and distributor plug harness.
- Slide the Adapter ORANGE and YELLOW WIRES through the grommet (supplied).
- Connect the Adapter ORANGE WIRE to the pickup plug's WHITE WIRE.
- Connect the Adapter YELLOW WIRE to the pickup plug's GREEN WIRE.
- Position the grommet into the slot on the edge of the distributor housing. Use cable ties and 8-32 screws to hold wires in place.
- Install the distributor cap.

**Connecting the Harness PART NO. 29040:**

- Connect the HYFIRE® IV Electronic Ignition Control's SMALL GREEN WIRE to the Harness RED WIRE.
- Connect the HYFIRE® IV Electronic Ignition Control's SMALL BLACK WIRE to the Harness BLACK WIRE.
- Connect the mating plug of the Harness to the mating plug of the Adapter Part No. 29043 from the distributor.

**Connecting the Ignition Control Harness:**

- Route the Ignition Control Harness to the coil so that its wires do not make contact with extreme heat, sharp objects or moving devices such as fans, belts and linkages.
- Crimp a spade terminal on the Ignition Control Harness RED WIRE.

**For coil-in-cap distributors only**

Refer to Figure 11 while performing the following steps.

- Connect the BAT PLUG/wire to the RED WIRE.
- Crimp the YELLOW WIRE to the YELLOW WIRE of the Adapter Part No. 29043 3-pin connector.
- Crimp the BLACK WIRE to the BROWN WIRE of the Adapter Part No. 29043 3-pin connector.
- Plug the Adapter Part No. 29043 3-pin connector into the distributor cap.
- Note: DO NOT connect the GREEN WIRE of the Ignition Control Harness to anything. Tape the end of it to insulate it.
- Go to Step 3, page 9.

**For external coil only**

Refer to Figure 12 while performing the following steps.

**(Replace the words "spade receptacle terminal" with "ring terminal" when after-market coils with post type terminals are used.)**

- Disconnect the BAT wire from the ignition coil BAT/(+) terminal. Connect the BAT wire to the RED WIRE.
- Disconnect the tachometer wire from the ignition coil TACH/(-) terminal.
- Crimp a spade receptacle terminal on the Ignition Control Harness YELLOW WIRE. Connect the YELLOW WIRE to the ignition coil BAT/(+) terminal. DO NOT allow any wire except the YELLOW WIRE to make contact with the ignition coil BAT/(+) terminal.
- Crimp a spade receptacle terminal on the Ignition Control Harness BLACK WIRE. Connect the BLACK WIRE to the ignition coil BAT/(-) terminal.
- Discard the adapter plug with the yellow and brown wires from the Adapter PART NO. 29043. It is not used on external ignition coil HEI systems.
- **Note: DO NOT connect the GREEN WIRE of the Ignition Control Harness to anything. Tape the end of it to insulate it.**
- Go to Step 3, page 9.

**Connecting to Mopar/Chrysler Electronic Systems (non-computer type) using Harness PART NO. 29040 for OEM magnetic pickup**

Refer to Figure 13 while performing the following steps.

- Disconnect all connectors at the ignition module, ignition coil and distributor. Remove the ignition module. Take notice of a DARK GREEN/RED WIRE connected to the ignition ballast resistor. Remove the distributor and coil harnesses.

**Connecting the Harness PART NO. 29040:**

- Connect the HYFIRE® IV Electronic Ignition Control's SMALL GREEN WIRE to the Harness RED WIRE.
- Connect the HYFIRE® IV Electronic Ignition Control's SMALL BLACK WIRE to the Harness BLACK WIRE.
- Connect the mating plug of the Harness to the distributor plug.

**Connecting the Ignition Control Harness:**

- Route the Ignition Control Harness to the ignition coil so that its wires do not make contact with extreme heat, sharp objects or moving devices such as fans, belts and linkages.
- Connect the RED WIRE to the terminal on the ignition ballast resistor that previously had the DARK GREEN/RED WIRE connected to it (or to a 12-volt wire from the ignition switch). **NOTE: The RED WIRE must get voltage when the ignition switch is in the START and RUN positions.**
- Connect the YELLOW WIRE to the ignition coil (+) terminal. DO NOT allow any wire except the YELLOW WIRE to make contact with the ignition coil (+) terminal.
- Connect the BLACK WIRE to the ignition coil (-) terminal.
- DO NOT connect the GREEN WIRE of the Ignition Control Harness to anything. Tape the end of it to insulate it.
- Go to Step 3, page 9.

**2BWiring method without adapters; all breaker point distributors; Mallory Electronic Ignitions (three wire/red, brown, green); OEM electronic ignition amplifiers.**

Refer to: *Figure 14 for breaker point distributors; Figure 16 for Mallory UNILITE® Distributors, Magnetic Breakerless Distributors or Electronic Advance Distributors (three wire/red, brown, green); Figure 17 for OEM electronic ignition amplifiers*

**Connecting the Ignition Control Harness**

- Route the Ignition Control Harness to the ignition coil so that its wires do not make contact with extreme heat, sharp objects or moving devices such as fans, belts and linkages.
- Disconnect ALL wires located on the ignition coil (+) terminal. These include the wires from the ignition switch/ignition ballast resistor, start/ignition bypass and any other wires normally connected to the ignition coil (+) terminal. Connect these wires to the RED WIRE. NOTE: The RED WIRE must get voltage when the ignition switch is in the START and RUN positions. If you are using a Mallory Electronic Ignition, connect its BROWN WIRE to engine ground and add its RED WIRE to the Ignition Control Harness RED WIRE. Use Ring Terminal Connectors to join wires together (See page 2 - Ignition Ballast Resistor / Loom Resistance Wire and Standard Ignition Bypass).
- Similarly, disconnect ALL wires located on the ignition coil (-) terminal. Connect these wires to the GREEN WIRE. If you are using a Mallory Electronic Ignition, add its GREEN WIRE to the Ignition Control Harness GREEN WIRE. Use Ring Terminal Connectors to join wires together.
- Connect the YELLOW WIRE to the ignition coil (+) terminal. DO NOT allow any wire except the YELLOW WIRE to make contact with the ignition coil (+) terminal.
- Connect the BLACK WIRE to the ignition coil (-) terminal.
- Go to Step 3, page 9.

**RING TERMINAL CONNECTORS:**

Furnished with the HYFIRE® IV Electronic Ignition Controls are two Ring Terminal Connectors for the convenience of getting a neat installation when the HYFIRE® IV Electronic Ignition Control is added to an existing ignition system. These Ring Terminal Connectors allow the existing ignition system wiring to remain in the area of the ignition coil.

- Move wires onto the stud that is inside the Ring Terminal Connector body.
- Secure these wires to the stud with the nut and washer.
- Install the Ring Terminal Connector cap.

**FIGURE 10**

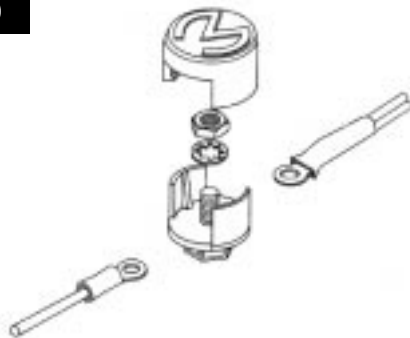

**2CWiring Method without adapters for Magnetic Pickup Trigger Pulses (Non-Computer Type); Magnetic Pickup Distributors or Crank Trigger Ignition**

Connecting to Magnetic Pickup Distributors and Crank Trigger Ignition – Refer to Figure 18.

- Connect the magnetic pickup (+) wire to the SMALL GREEN WIRE from the HYFIRE® IV Electronic Ignition Control.
- Connect the magnetic pickup (-) wire to the SMALL BLACK WIRE from the HYFIRE® IV Electronic Ignition Control.

**Connecting the Ignition Control Harness:**

- Route the Ignition Control Harness to the ignition coil so that its wires do not make contact with extreme heat, sharp objects or moving devices such as fans, belts and linkages.
- Connect the RED WIRE to the 12-volt wire from the ignition switch. NOTE: The RED WIRE must get voltage when the ignition switch is in the START and RUN positions. Use a Ring Terminal Connector to join wires together.
- Connect the YELLOW WIRE to the ignition coil (+) terminal. DO NOT allow any wire except the YELLOW WIRE to make contact with the ignition coil (+) terminal.
- Connect the BLACK WIRE to the ignition coil (-) terminal.
- DO NOT connect the GREEN WIRE of the Ignition Control Harness to anything. Tape the end of it to insulate it.
- Go to Step 3, Page 9.

MAGNETIC PICKUP/CRANK TRIGGER COLOR CODES		
BRAND/TYPE	MAG+	MAG-
MALLORY CRANK TRIGGER	PURPLE	GREEN
MALLORY BILLET COMPETITION DISTRIBUTOR, SERIES NOS. 81 AND 84	ORANGE	PURPLE
MALLORY COMP 9000® SERIES NOS 96-99	ORANGE	PURPLE
MALLORY HARNESS PART NO. 29040	RED	BLACK
MSD™ CRANK TRIGGER	PURPLE	GREEN
MSD™ CRANK TRIGGER (OLD STYLE)	ORANGE	BLACK
MSD™ DISTRIBUTOR	ORANGE	PURPLE
MOROSO™ CRANK TRIGGER	BLACK	WHITE
ACCEL® CRANK TRIGGER	BLACK	WHITE
CHRYSLER ELECTRONIC DISTRIBUTOR	ORANGE	BLACK
FORD DURASPARK DISTRIBUTOR	ORANGE	PURPLE
DELCO/GM HEI DISTRIBUTOR	WHITE	GREEN



**FIGURE 11**

# GM/DELCO HEI DISTRIBUTOR

(WITH COIL MOUNTED INSIDE DISTRIBUTOR CAP)

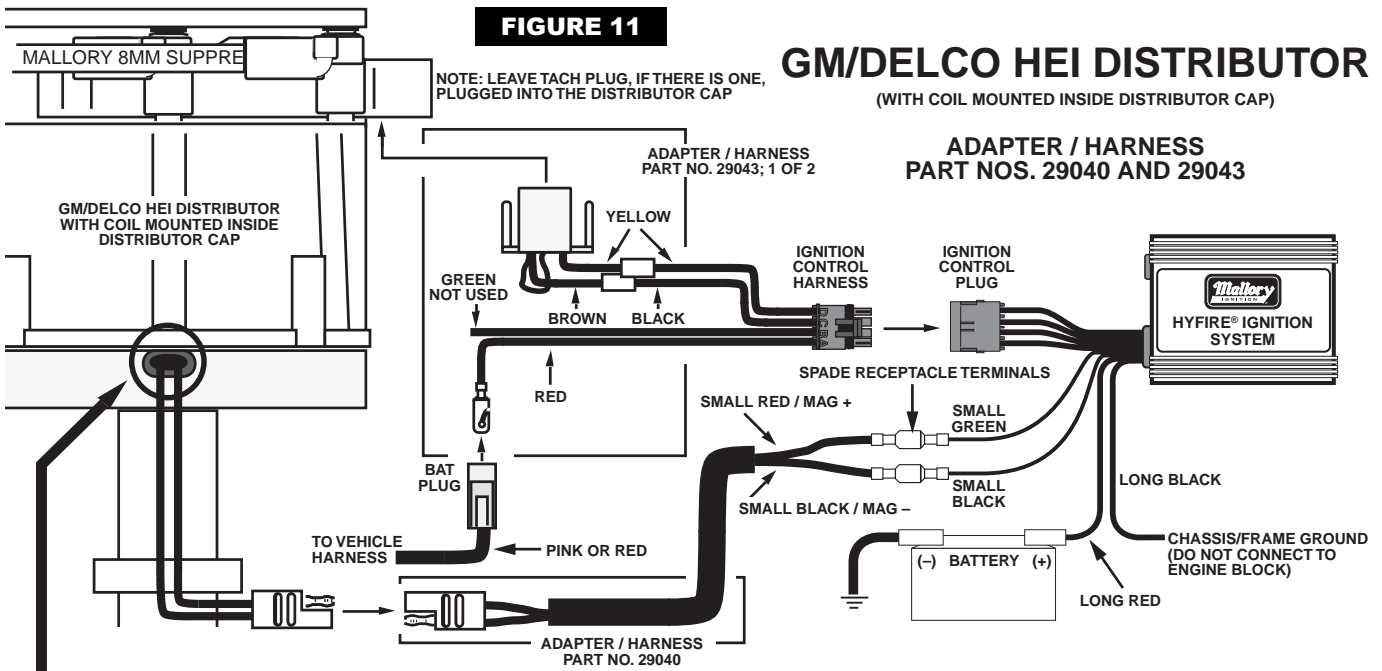

**FIGURE 12**

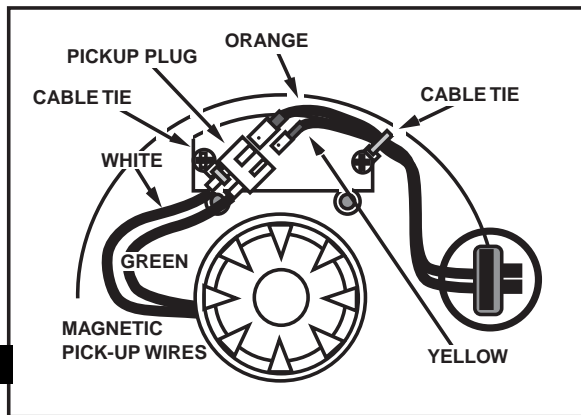

# GM/DELCO HEI DISTRIBUTOR

(WITH REMOTE COIL ADAPTER)

ADAPTER / HARNESS PART NOS. 29040 AND 29043

NOTE: DISCARD ADAPTER / HARNESS PART NO. 29043 WITH YELLOW AND BROWN WIRES.

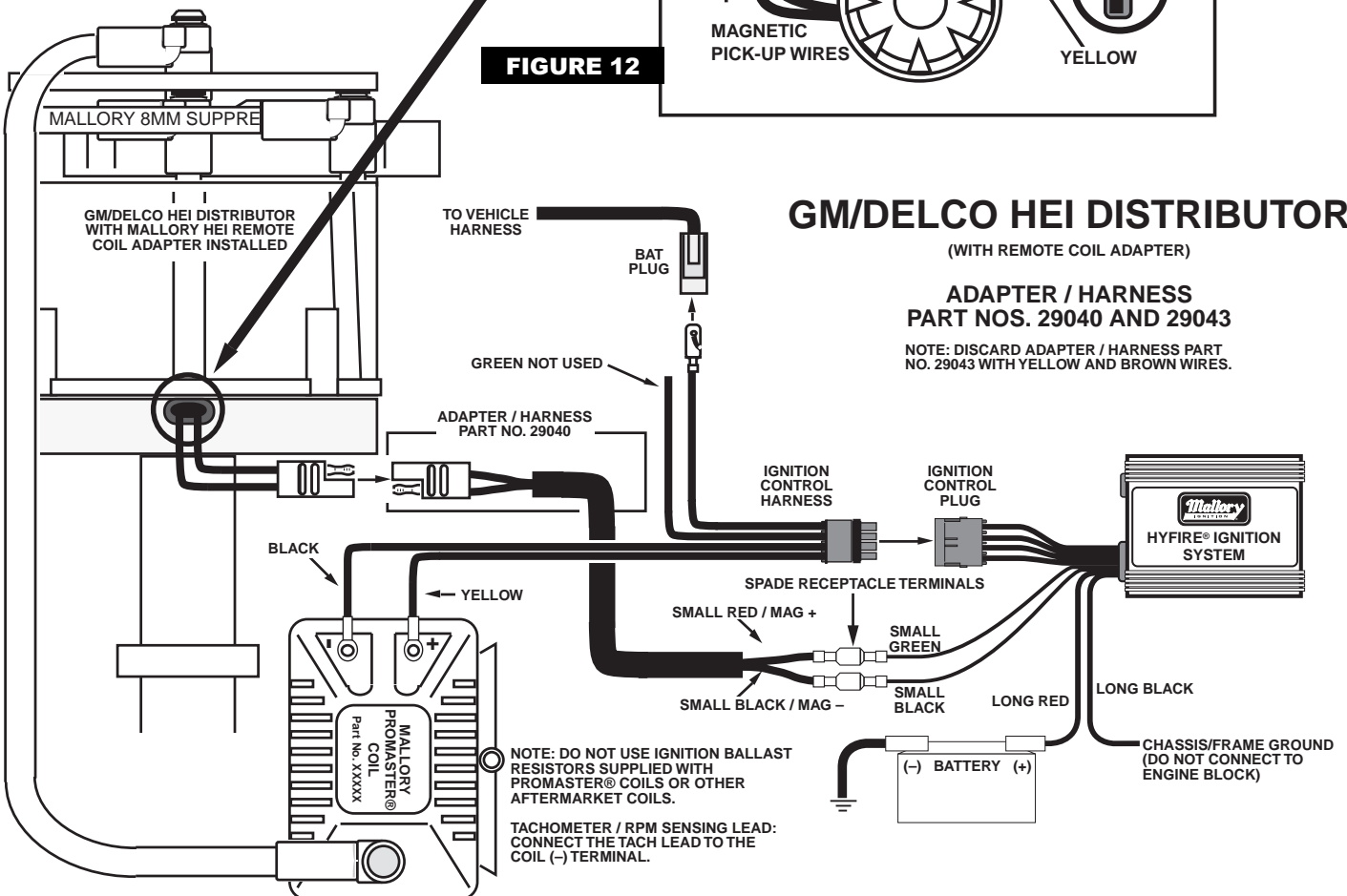

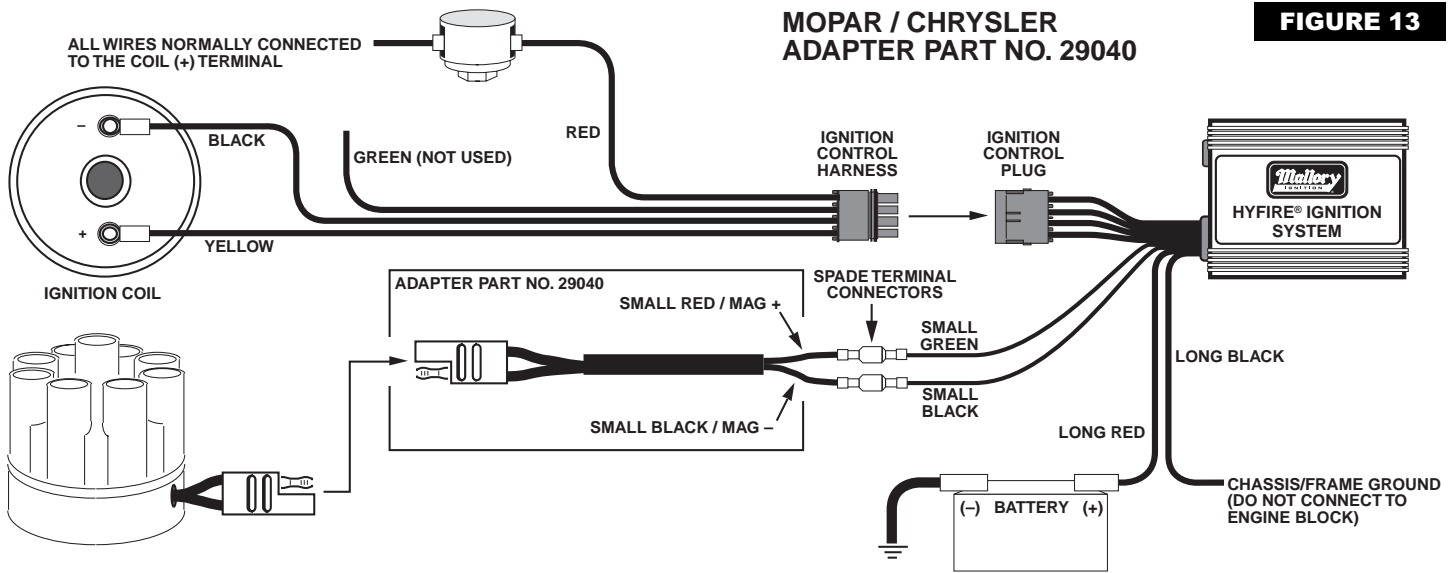
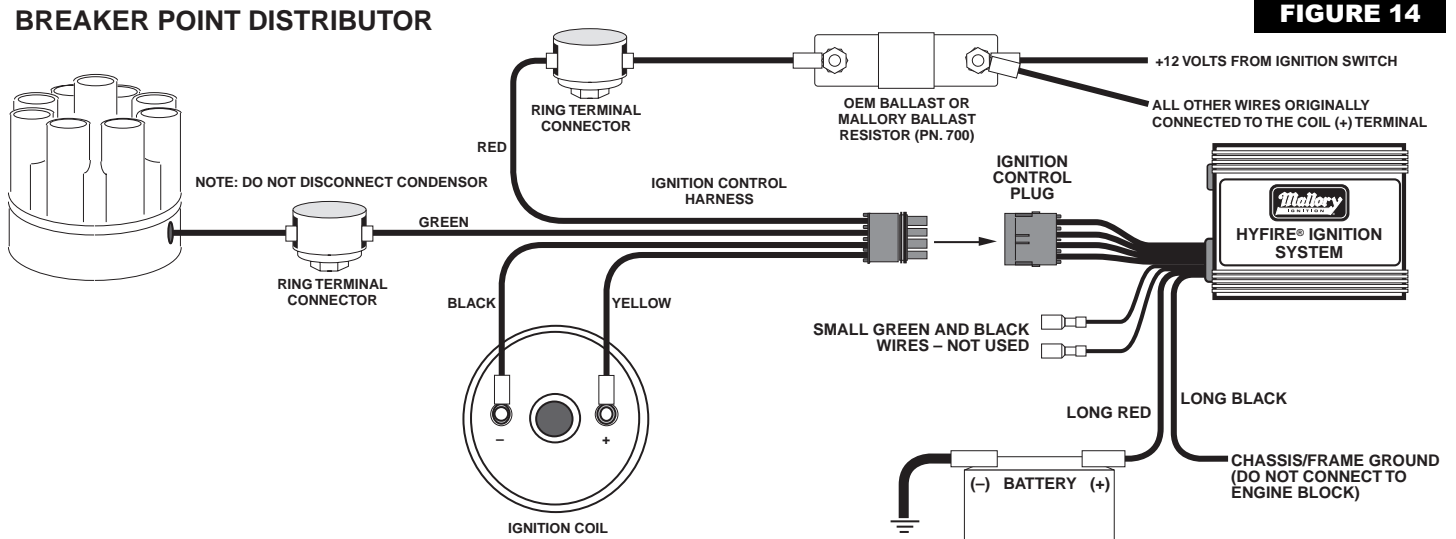

**FIGURE 13****FIGURE 14****FIGURE 15****Step 3****Tachometer Operation:**

If a tachometer is used, connect tachometer ignition sensing lead to the TACH terminal on the HYFIRE® IV Electronic Ignition Control.

If the tachometer does not work after being connected to the TACH terminal, connect the tachometer ignition sensing lead to the GREEN WIRE from the Ignition Control Harness. Install the Mally Fuel Injection and Tachometer Adapter Part No. 29074 to supply the proper signal for the tachometer to operate.

**Step 4**

Secure all wires with cable ties to prevent contact extreme heat, sharp objects or moving devices such as fans, belts and linkages.

**Step 5**

Recheck all wire and connections to ensure they are correct before applying power.

**Step 6**

Connect the battery (-) terminal cable. Start engine and check operation of the ignition system.

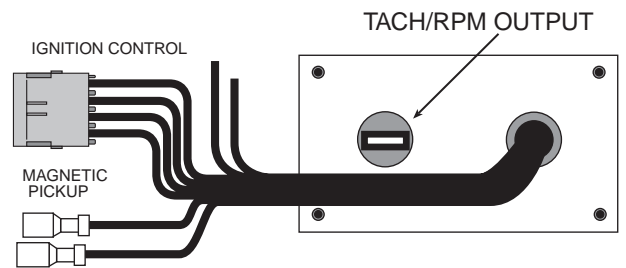

**FIGURE 16**

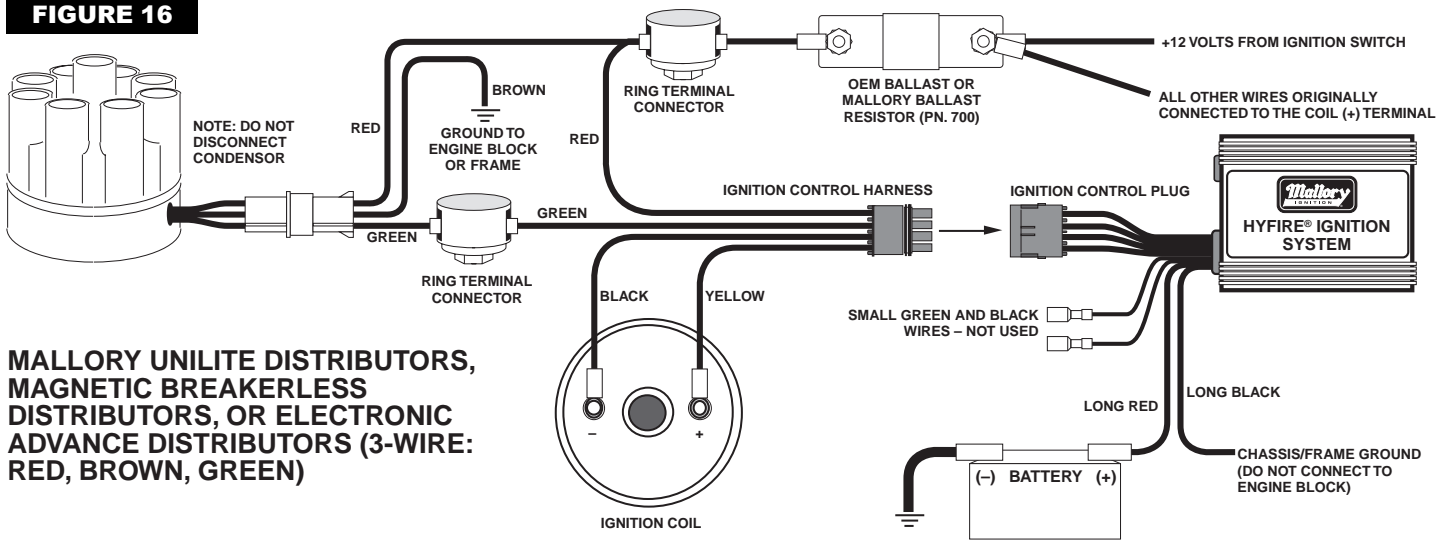

**OEM IGNITION AMPLIFIER**

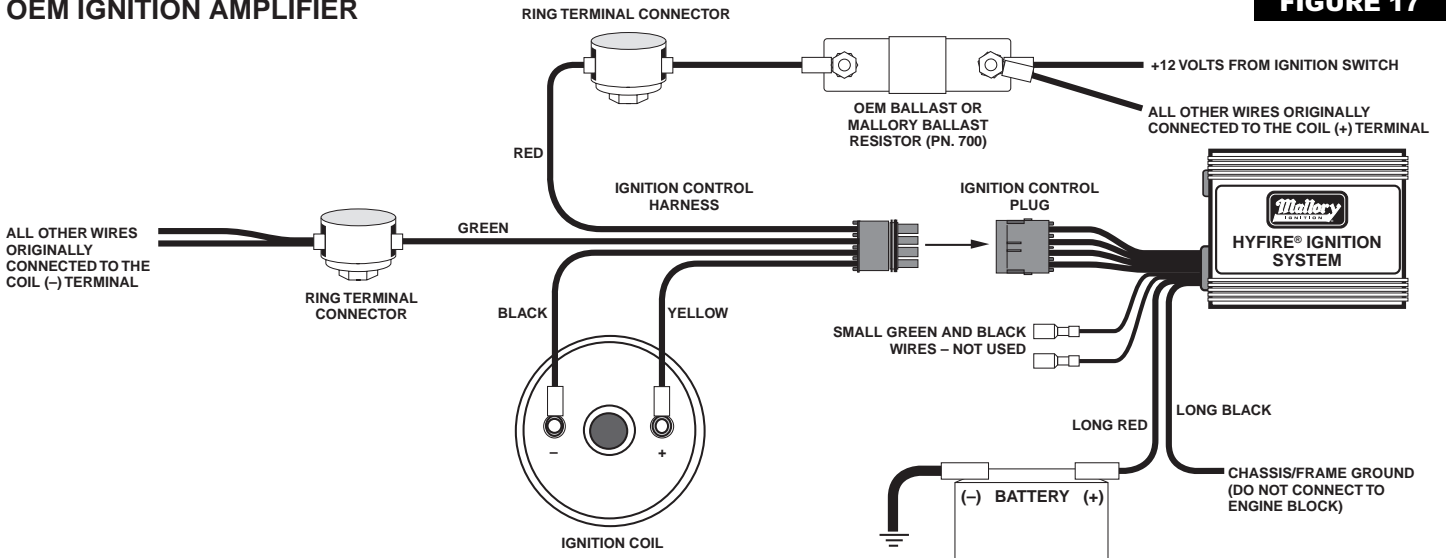

**MAGNETIC PICK-UP DISTRIBUTOR OR CRANK TRIGGER IGNITION**

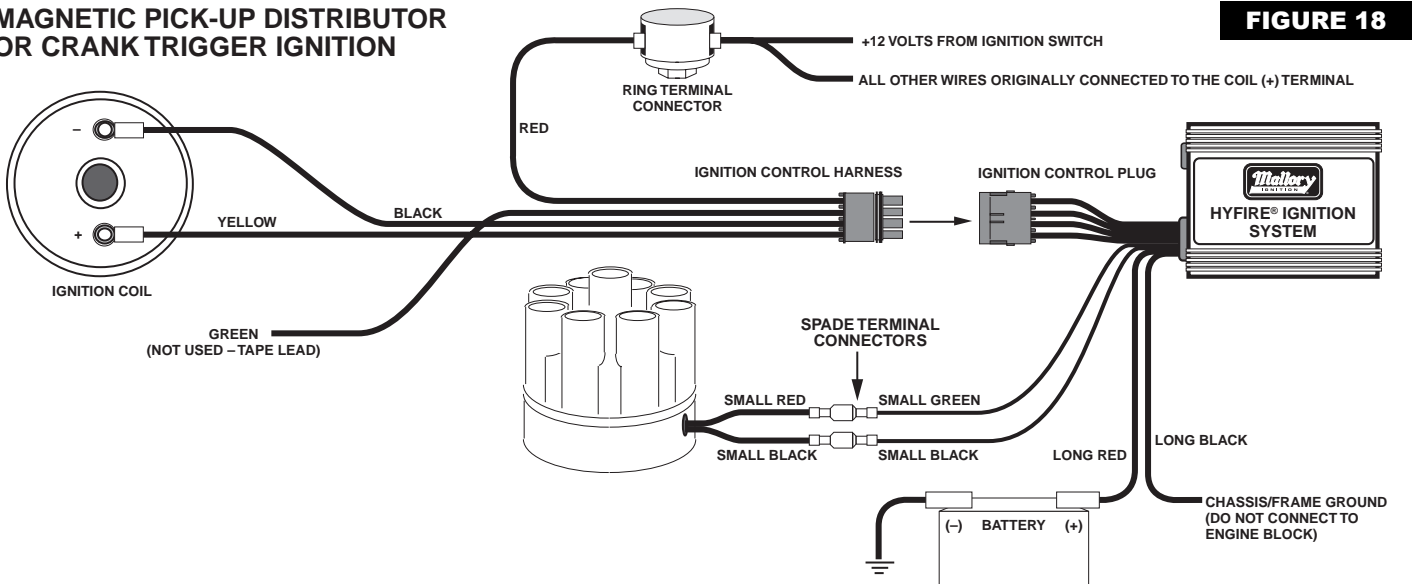

## RPM LIMITER OPERATION

### HYFIRE® IVC Ignition System Part No. 692 only

The HYFIRE® IVC Ignition System has a microcomputer controlled RPM limiting system. The RPM limiting system has an engine protection RPM limiter and a staging control RPM limiter. The staging control RPM limiter is triggered by applying 12 volts to the ORANGE WIRE. Connect the ORANGE WIRE to 12-volt/line-lock, trans-brake or manual/toggle switches.

The RPM limiters are adjustable from 1,000 to 12,000 RPM in increments of 100 RPM. The engine protection RPM limiter is factory set at 4,000 RPM.

NOTE: The engine protection RPM limiter must be set between 1,000 and 12,000 RPM. Any other RPM setting outside the adjustment range stops the ignition system from operating. The ignition system will resume operation once the engine protection RPM limiter is set properly between 1,000 and 12,000 RPM.

If you are not going to use the engine protection RPM limiter, set the RPM value higher than your engine will normally run (up to 12,000 RPM). Similarly, if you are not going to use the staging control RPM limiter, avoid applying 12 volts to the ORANGE WIRE.

The RPM limiter switches for setting the RPM limiters are under the slide-back cover on top of the housing. Loosen the four screws and slide the cover to see the RPM limiter switches. You will see two sets of RPM limiter switches. One set of switches is marked "HIGH SIDE". These are the engine protection RPM limiter switches. One set of switches is marked "STAGE". These are the staging control set of RPM limiter switches. Between the two switches is a number indicator. It has markings of "1000" and "100" along with markings of "8, 4, 2 and 1." Switches of each limiter are set ON to add combinations of 1, 2, 4 and 8 of each switches' hundred and thousand sections. Notice that the switches are marked "ON" in their corner.

EXAMPLE: If you want to set the engine protection at 7,300 RPM, set the HIGH SIDE switches' thousand section to 8-off, 4-ON, 2-ON and 1-ON (4+2+1=7 thousand). Similarly, set the HIGH SIDE switches' hundred section to 8-off, 4-off, 2-ON and 1-ON (2+1=3 hundred). As stated earlier, if you are not going to use the engine protection RPM limiter, set the RPM value higher than your engine will normally run (up to 12,000 RPM).

EXAMPLE: If you want to set the staging control at 5,600 RPM, set the STAGE switches' thousand section to 8-off, 4-ON, 2-off and 1-ON (4+1=5 thousand). Similarly, set the STAGE switches' hundred section to 8-off, 4-ON, 2-ON and 1-off (4+2=6 hundred). The staging control RPM limiter is triggered by applying 12 volts to the ORANGE WIRE. Connect the ORANGE WIRE to 12-volt/line-lock, trans-brake wire or manual/toggle switches.

NOTE: The RPM limiting systems will not work properly with odd-fire V6 applications. The RPM limiting systems are not recommended as an engine speed governor. Similarly, forcing engine RPM past the RPM limiter continuously for long intervals can cause problems resulting from fuel build up in the exhaust system that may adversely affect exhaust oxygen sensors (if used) and cause severe backfiring.

**FIGURE 19**

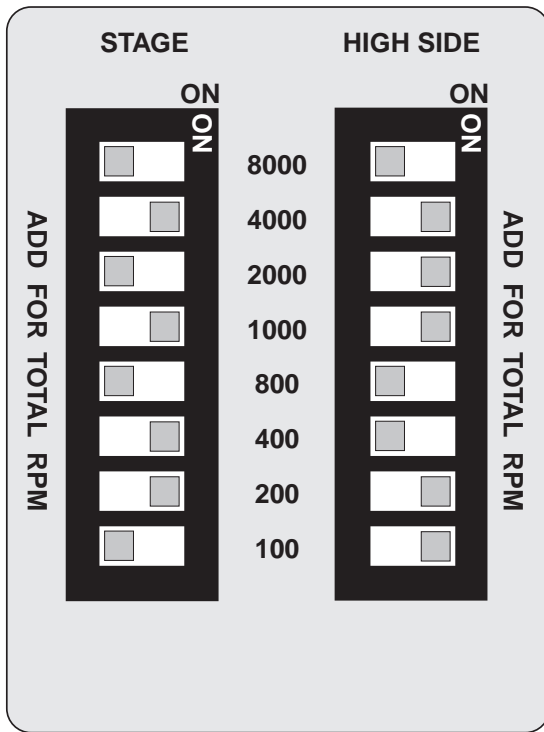

**STAGING  
RPM  
EXAMPLE:  
5,600 RPM**

**ENGINE  
PROTECTION  
RPM  
EXAMPLE:  
7,300 RPM**

## OPTIONAL IGNITION ACCESSORIES

### Single Stage High Speed Retard – Part No. 618-1

Mallory's Single Stage High Speed Retard is a finger tip adjustable ignition timing retard control. The adjustment knob provides full adjustment range of 0°-15°. This retard is designed with matching mating plugs so it can be added between the HYFIRE® IV Electronic Ignition Control and the Ignition Control Harness.

### Multi Stage High Speed Retard – Part No. 618-3

This is a finger tip adjustable 3-stage timing retard control with an adjustment range for the first and second stage of 0°-15° and a range of 0°-20° for the third stage. Each succeeding stage overrides the previous stage to allow you to reduce (or add) ignition timing on a succeeding stage. This retard is designed with matching mating plugs so it can be added between the HYFIRE® IV Electronic Ignition Control and the Ignition Control Harness.

### Mallory Electronic Advance Computer – Part Nos. 600-04, 600-06 and 600-08

This is a user programmable advance curve system using a CMOS microprocessor for advance calculations. This allows you to select from 256 different advance curve combinations! It is designed with matching mating plugs so it can be added between the HYFIRE® IV Electronic Ignition Control and the Ignition Control Harness.

### Mallory Remote Timing Control – Part No. 631

Mallory's Remote Timing Control allows you to change the ignition timing as you drive for maximum performance, for better fuel economy or to avoid engine knock.

**NOTE: The accessories listed above will not work properly with odd-fire V6 applications or point trigger distributors. They are not designed for marine use.**

### Mallory RPM Activated Switch – Part No. 627A

This device is programmable from 3,000-10,800 RPM in increments of 100 RPM. It features integral 5 amp relay contacts to operate 12-volt or ground circuits with connections for normally open and normally closed operation. It works with any 8, 6 (includes odd-fire, semi-even fire, and even-fire V6 engines), or 4 cylinder application and triggers from the tach output terminal on the HYFIRE® IV Electronic Ignition Control.

### Mallory Fuel Injection and Tachometer Adapter – Part No. 29074 and 29078

Some applications with fuel injection or a tachometer need a voltage spike signal from the negative side of the coil before they will operate properly. This signal changes once the HYFIRE® IV Electronic Ignition Control is installed. Mallory's adapter provides the proper signal to trigger most fuel injection systems and voltage/current triggered tachometers.

**BYPASS CONNECTOR**

**FIGURE 20**

The Bypass Connector (standard ignition bypass) fits into the mating plug of the Ignition Control Harness to convert back to standard ignition. If you use the Bypass Connector, use ignition ballast resistors designed for the particular distributor and coil in the wire from the ignition switch. **DO NOT** put the Bypass Connector into the mating plug of a Mallory HYFIRE® IV RPM Limiting Adapter, or Single or Multi Stage High Speed Retard. **DO NOT** put the Bypass Connector into the mating plug of a Mallory Electronic Advance Computer or Remote Timing Control. Use the Power Plug to convert back to standard ignition. Also, if you are using a Mallory Fuel Injection/Tachometer Adapter (Part No. 29074), disconnect it (and its diode if used) as part of converting back to standard ignition. The Bypass Connector (standard ignition bypass method to convert back to standard ignition) does not work with magnetic pickup distributors or crank trigger ignition.

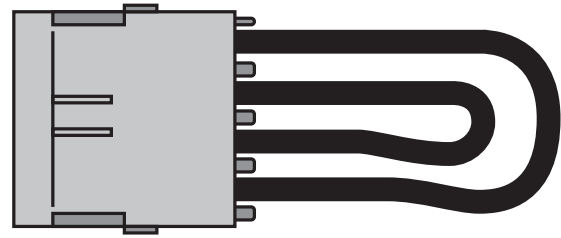

**FIGURE 21**

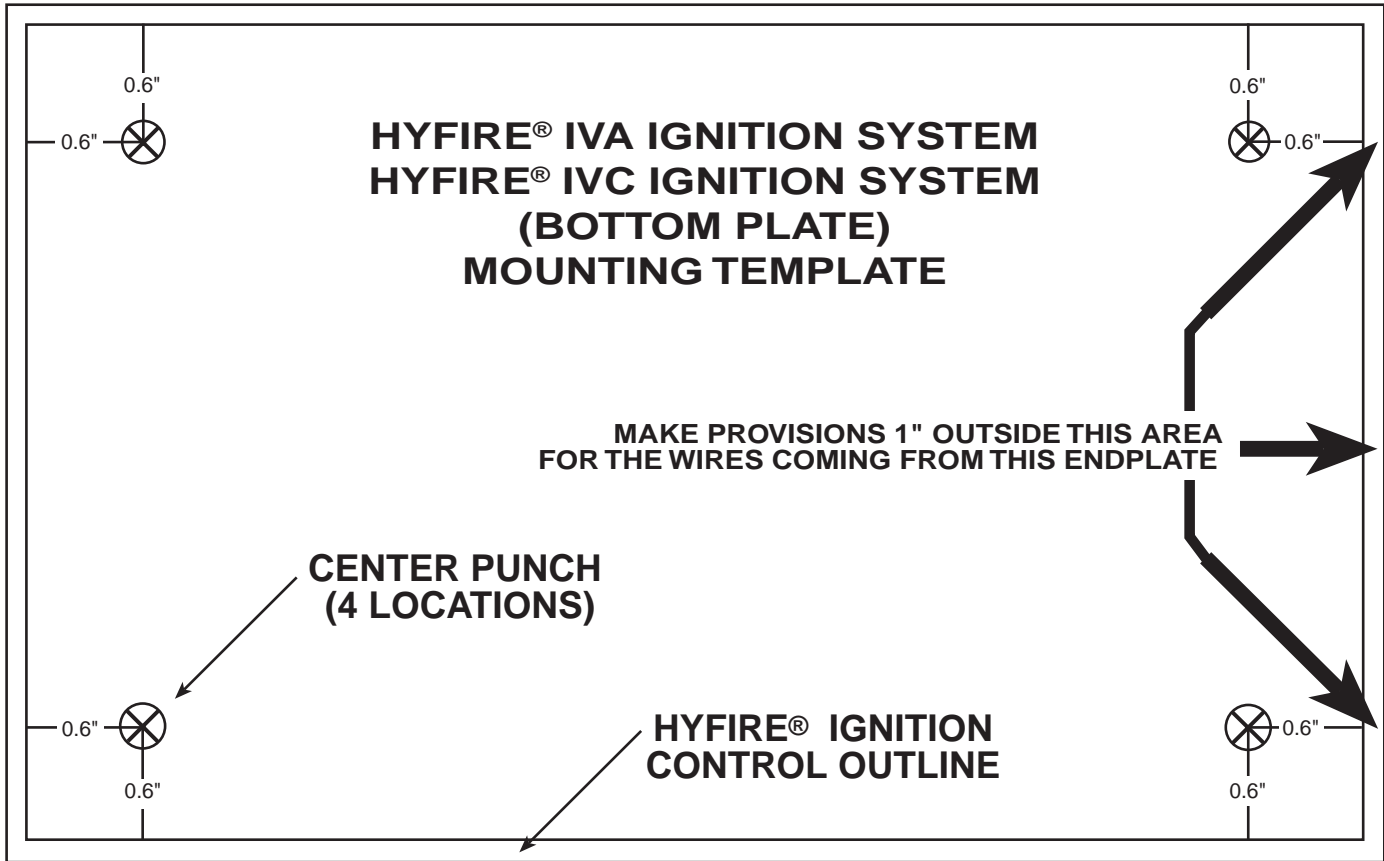

MALLORY IS A DIVISION OF THE MR. GASKET PERFORMANCE GROUP  
550 MALLORY WAY, CARSON CITY, NEVADA 89701  
(775) 882-6600 FAX (775) 887-4326  
www.mrgasket.com

FORM 1351  
(REV. E) 10/99  
Made in U.S.A.  
Printed in U.S.A.